

**TRUE TEMPERATURE
INDICATOR
MODEL TTI-22**
User Maintenance Manual/Handbook

Isothermal Technology Limited, Pine Grove, Southport, PR9 9AG, England
Tel: +44 (0)1704 543830 Fax: +44 (0)1704 544799 Internet: www.isotech.co.uk E-mail: info@isotech.co.uk

The company is always willing to give technical advice and assistance where appropriate. Equally, because of the programme of continual development and improvement we reserve the right to amend or alter characteristics and design without prior notice. This publication is for information only.

CONTENTS

PGUARANTEE	4
1. ABOUT THE INSTRUCTION MANUAL	5
2. SAFETY INSTRUCTIONS	5
2.1 GENERAL SAFETY INSTRUCTIONS	5
2.1.1 <i>Liability</i>	5
2.1.2 <i>Installation and Use</i>	5
2.1.3 <i>Maintenance and Service</i>	6
2.1.4 <i>Disposal</i>	6
2.2 SPECIAL SAFETY INSTRUCTIONS	6
2.3 SAFETY SYMBOLS ON THE INSTRUMENT	7
3. TTI-22 - AN OVERVIEW	8
4. CHECKING THE SUPPLIED PARTS	9
5. OPERATING ELEMENTS AND INSTRUMENT CONNECTIONS	10
5.1 TTI-22 FRONT SIDE.....	10
5.1.1 <i>Display and Function Keys</i>	10
5.1.2 <i>Instrument Connections on Front Side</i>	11
5.2 TTI-22 REAR SIDE.....	12
5.2.1 <i>Terminal Assignment of RS232</i>	12
5.2.2 <i>Ethernet Terminal</i>	12
5.2.3 <i>External Power Adapter</i>	12
5.2.4 <i>Battery Supply</i>	13
6. PUTTING TTI-22 INTO OPERATION	14
6.1 ASSEMBLING THE MEASURING SYSTEM.....	14
6.2 PUTTING THE MEASURING SYSTEM INTO OPERATION.....	15
6.2.1 <i>Getting Started with Pre-stored Sensor Parameters</i>	15
6.2.2 <i>Getting Started without Stored Sensor Parameters</i>	16
6.2.3 <i>Switching TTI-22 Off</i>	16
7. CONFIGURING TTI-22	17
7.1 SETTING A PASSWORD.....	17
7.2 SETTING DATE AND TIME.....	18
7.3 SETTING THE TEMPERATURE UNIT.....	18
7.4 SETTING BACKLIGHT AND CONTRAST.....	19
7.5 ENTERING SENSOR PARAMETERS AND ASSIGNING TO A SENSOR INLET	19
7.5.1 <i>Entering or Changing Calibration Parameters for a Sensor</i>	19
7.5.2 <i>Assigning Calibration Parameters to a Sensor Channel</i>	22
7.5.3 <i>Assigning Calibration Parameters to a Sensor Channel via PC/RS232</i>	22
7.6 SELECTING DISPLAY TYPE.....	22
7.7 PERFORMING A SELF-HEATING TEST.....	24
8. READING OUT MEASURING DATA	25
8.1 TRANSFERRING MEASURING DATA VIA RS232.....	25
8.2 TRANSFERRING MEASURING DATA VIA ETHERNET.....	28
9. CALIBRATING AND ADJUSTING TTI-22	29
10 LOCKING CALIBRATION PARAMETERS	30
11. OVERVIEW OF THE MENU STRUCTURE	31
11.1 MAIN MENU	31
11.2 SEL. DISPLAY & START (DISPLAY TYPE SELECTION)	32
11.3 EDIT CONFIGURATION.....	32
APPENDIX A: TECHNICAL DATA	34
A.1 TTI-22 AS HIGH-PRECISION RESISTANCE METER.....	34



- A.2 TTI-22 AS HIGH-PRECISION THERMOMETER (SPECIFICATIONS WITHOUT SENSOR) 34
- A.3 GENERAL INSTRUMENT DATA 35
- APPENDIX B: DECLARATION OF CONFORMITY 36**
- APPENDIX C: TROUBLESHOOTING 37**
 - C.1 TTI-22 ERROR MESSAGES 37
 - C.2 PC ERROR MESSAGES 38
 - C.3 PROBLEMS WITH INSTRUMENT ACTIVATION 39
- APPENDIX D: TEMPERATURE CALCULATION METHODS 40**
 - D.1 DIN IEC 751: INDUSTRIAL PLATINUM RESISTANCE THERMOMETERS AND PLATINUM MEASURING RESISTORS 40
 - D.2 INTERNATIONAL TEMPERATURE SCALE 1990 (ITS-90) 41
- APPENDIX E: CALIBRATING AND ADJUSTING TTI-22 43**
 - E.1 CALIBRATING AND ADJUSTING TTI-22 43
 - E.2 CALIBRATING AND ADJUSTING THE SENSOR 46
- APPENDIX F: CONVERTING THE TEMPERATURE UNIT 47**
- APPENDIX G: FIRMWARE VERSIONS 48**
- DECLARATION OF CONFORMITY 49**

GUARANTEE

This instrument has been manufactured to exacting standards and is guaranteed for twelve months against electrical break-down or mechanical failure caused through defective material or workmanship, provided the failure is not the result of misuse. In the event of failure covered by this guarantee, the instrument must be returned, carriage paid, to the supplier for examination and will be replaced or repaired at our option.

FRAGILE CERAMIC AND/OR GLASS PARTS ARE NOT COVERED BY THIS GUARANTEE

INTERFERENCE WITH OR FAILURE TO PROPERLY MAINTAIN THIS INSTRUMENT MAY INVALIDATE THIS GUARANTEE

RECOMMENDATION

The life of your **ISOTECH** Instrument will be prolonged if regular maintenance and cleaning to remove general dust and debris is carried out.

We recommend that this instrument to be re-calibrated annually.

ISOTECH

ISOTHERMAL TECHNOLOGY LTD.
PINE GROVE, SOUTHPORT
PR9 9AG, ENGLAND

TEL: +44 (0) 1704 543830/544611

FAX: +44 (0) 1704) 544799

The company is always willing to give technical advice and assistance where appropriate. Equally, because of the programme of continual development and improvement we reserve the right to amend or alter characteristics and design without prior notice. This publication is for information only.

1. About the Instruction Manual

This instruction manual informs you about the installation and the safe handling and use of the instrument. Make sure that the instruction manual is easily accessible to all personnel involved with the instrument. Pay special attention to the safety instructions and warnings in the manual and on the instrument.

Symbols in this Instruction Manual

This instruction manual features the following symbols:



Warning: This symbol calls attention to **the risk of accidental injuries or damage to goods**. Do not proceed until the indicated conditions for averting this threat are fully understood and met.



Caution: This symbol calls attention to **the risk of instrument damage or measurement errors**. Do not proceed until the indicated conditions for averting this threat are fully understood and met.



Information: This symbol calls attention to any **additional information** of use to the operator.

2. Safety Instructions

- Read the instruction manual at hand before using TTI-22.
- Follow all hints and instructions contained in this instruction manual to ensure the correct use and safe functioning of TTI-22.

2.1 General Safety Instructions

2.1.1 Liability

- The instruction manual at hand does not claim to address all safety issues associated with the use of the instrument and samples. It is your responsibility to establish health and safety practices and determine the applicability of regulatory limitations.
- Isothermal Technology Ltd only warrants the proper functioning of TTI-22 if no adjustments have been made to the mechanics, electronics, and software.
- Only use TTI-22 for the purpose described in this instruction manual. Isothermal Technology Ltd is not liable for damages caused by incorrect use of TTI-22.

2.1.2 Installation and Use

- TTI-22 is not an explosion-proof instrument and therefore must not be operated in areas with risk of explosion.
- TTI-22 is only suitable for inside use.
- The installation procedure should only be carried out by authorized personnel who are familiar with the installation instructions.

- Do not use any accessories or wearing parts to TTI-22 other than those supplied or approved by Isothermal Technology Ltd.
- Make sure all operators are trained to use the instrument safely and correctly before starting any applicable operations.
- In case of damage or malfunction, do not continue operating TTI-22. Do not operate the instrument under conditions which could result in damage to goods and/or injuries and loss of life.
- Check if the wetted parts are chemically resistant to the samples and rinsing agents.

2.1.3 Maintenance and Service

- The results delivered by TTI-22 not only depend on the correct function of the instrument, but also on various other factors. We therefore recommend to have the results checked (e.g. plausibility tested) by skilled personnel before consequential actions are taken based on the results.
- Service and repair procedures may only be carried out by authorized personnel or by Isothermal Technology Ltd.

2.1.4 Disposal

- Concerning the disposal of TTI-22 observe the legal requirements in your country.

2.2 Special Safety Instructions

- Only use shielded cables for connecting the sensors.
- Only connect separated extra low voltage circuits (SELV according to EN60950) to the instrument.
- Keep an appropriate term for repeating the calibration of the used reference resistor and/or sensor. Recalibrate TTI-22 and sensors at least once a year.
- The following cases require you to perform an instrument self-check (turn off the instrument for at least 3-4 seconds) and control the set parameters (RRef, Sensor Calibration, User Password):
 - before large measuring cycles
 - after extraordinary operating conditions
 - after service work on the instrument
- Avoid exposing TTI-22 to direct sunlight and major temperature changes. After large ambient temperature changes, TTI-22 requires some time to adjust to the ambient conditions.

2.3 Safety Symbols on the Instrument

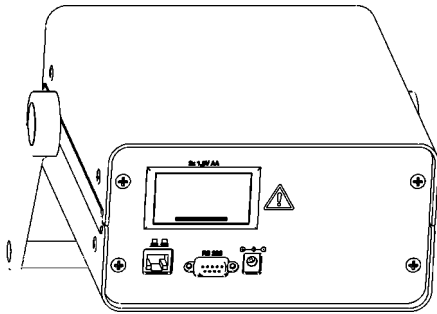

Fig. 2 – I Warning symbol next to the battery compartment

There is a warning sign on the rear of the instrument, next to the battery compartment.



Warning:

- Observe the correct polarity when placing the batteries.
- Only use 1.5 V AA batteries or 1.2 V AA rechargeable batteries of the same type and charge condition.

3. TTI-22 - An Overview

The TTI-22 measures temperatures in °C, K or °F with exceptional accuracy. Combined with calibrated high-precision platinum resistance thermometers, TTI-22 allows a reduction of system measurement uncertainties to an absolute minimum of as little as 1mK (0.001°C).

Connect TTI-22 to one or two Pt 100 industrial platinum resistance thermometers, whose temperature is calculated according to DIN IEC751. Pt 25.5 or Pt 100 standard platinum resistance thermometers are also suitable for use as temperature sensors. The temperature of standard thermometers is calculated according to ITS-90 (International Temperature Scale 1990). Individual calibration parameters for up to 30 different sensors can be stored. This provides easy recalibration and good traceability of the temperature measurement.

TTI-22 is operated via a menu-driven user interface. The current value, the mean value and the standard deviation of 5 up to 50 values can be continuously displayed. The self-heating effect of the sensor can be determined via the integrated self-heating test. TTI-22 has a serial RS232 interface and an Ethernet terminal. The installed web server delivers all important data to any given browser via internet or intranet.

4. Checking the Supplied Parts

TTI-22 was tested and packed carefully before shipment. However, damages may occur during transport.

1. Keep the packaging material (box, foam piece, transport protection) for possible returns and further questions from the transport and insurance company.
2. Check the delivery for completion by comparing the supplied parts to those noted in Table 4.1
3. If a part is missing, contact your Isotech representative.
4. If a part is damaged, contact the transport company and your Isotech representative.

Table 4.1: Supplied Parts

Pcs.	Article Description
1	TTI-22
1	Instruction manual
1	RS232 cable
2	Lemo connectors to suit TTI-22
1	Mains Lead
1	Traceable calibration certificate
1	UKAS calibration certificate (<i>optional extra</i>)
1	Carrying case (<i>optional extra</i>)
1	Power supply
2	AA Batteries

5. Operating Elements and Instrument Connections

5.1 TTI-22 Front Side

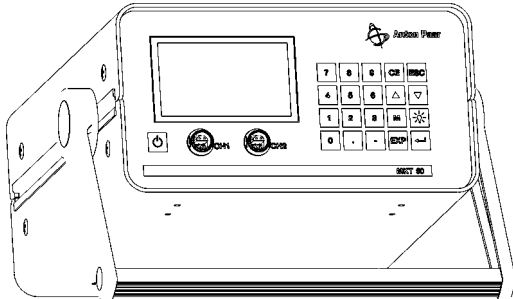

Fig. 5 – 1 Front view

5.1.1 Display and Function Keys

Function keys

0,1,2,..., 9 (numerical keys)	Menu selection and digit input
CE (CLEAR, BACKSPACE)	To delete the last entered character
ESC (ESCAPE)	<ul style="list-style-type: none"> In the menu mode: To change to the next higher menu level In an active input field: To abort the input. The input is cancelled and the prior field content is restored
▲ ▼	<ul style="list-style-type: none"> To toggle between menu items or input fields within one menu In statistics menus: To change the amount of measuring values applied for calculating the mean value and the standard deviation
M (menu)	To change from measurement mode to menu mode
	Backlight On/Off
EXP	To enter the exponent of a number
↵ (ENTER)	To confirm the input
	<On/Off> key

Display:

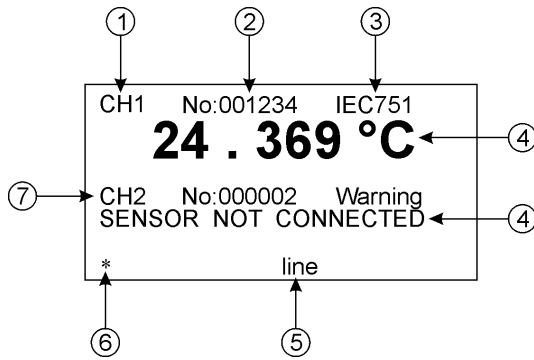

- 1 Sensor input 1 (channel 1)
- 2 Calibration number of sensor
- 3 Temperature calculation method or 'Warning'
- 4 Temperature display or error message
- 5 Power supply
- 6 Symbol for measurement mode (blinking)
- 7 Sensor input 2 (channel 2)

Fig. 5 - 2 Example of a display

5.1.2 Instrument Connections on Front Side

You can connect up to two sensors to TTI-22 via 4-pole sockets (Fig. 5 - 1, "CH 1" and "CH 2") type LEMO IS304.

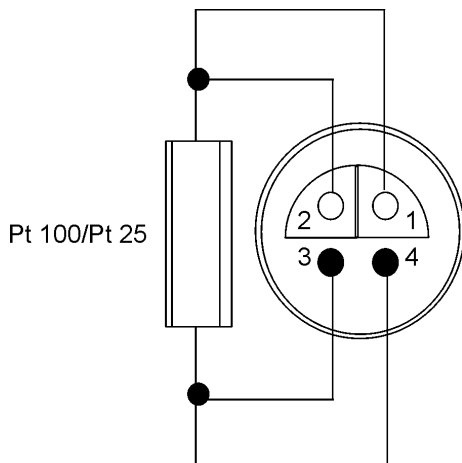
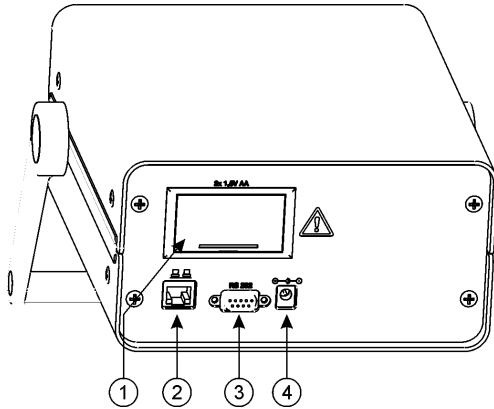

Fig. 5 - 3 Assignment of LEMO socket

5.2 TTI-22 Rear Side



- 1 Battery compartment for two batteries type AA
- 2 Ethernet (LAN)
- 3 RS232 serial interface
- 4 Inlet for external power adapter

Fig. 5 - 4 Rear view

5.2.1 Terminal Assignment of RS232

- Pin 1: not assigned
- Pin 2: TXD (transmit data)
- Pin 3: RXD (receive data)
- Pin 4: not assigned
- Pin 5: GND (ground)
- Pin 6: not assigned
- Pin 7: not assigned
- Pin 8: not assigned
- Pin 9: not assigned

5.2.2 Ethernet Terminal

The LAN terminal type RJ45 complies with the standard IEEE 802.3 (10 MBit).

5.2.3 External Power Adapter

Connect the delivered power adapter to the inlet (see (4) inlet for power adapter in Fig. 5 - 4). The power supply is 7.5 V DC at a maximum of 3 A. As long as a power adapter is connected, the batteries are not used.

5.2.4 Battery Supply

**Warning:**

- Observe the correct polarity when placing the batteries.
- Only use 1.5 V AA batteries or 1.2 V AA rechargeable batteries of the same type and charge condition.

Under typical operating conditions the delivered Alkaline cells run for approx. 10 hours. In case of frequent battery usage, we recommend the use of rechargeable batteries for environment protection.

The use of backlight, RS232 or the network cuts the battery runtime short. When using these features, use batteries with large capacity (>2000 mAh).

Changing batteries

To open the lid of the battery compartment, stick a screwdriver into the mould and press the lid down, away from the housing.

Observe the correct polarity when placing the new batteries (see sign in battery compartment).

Charging batteries

Remove rechargeable batteries from the instrument for charging them.

6. Putting TTI-22 into Operation

1. Check if the calibration numbers on these parts are identical:
 - on the factory or UKAS calibration certificate
 - directly at the sensor
 - on the parameter printout, if existent ("Configuration Parameters")
2. Check if the serial number on TTI-22 (on the rear side of the instrument) matches the number on the optional parameter printout ("Configuration Parameters").
3. If the above-mentioned numbers do not match, be sure to contact the manufacturer or supplier of the instrument.

6.1 Assembling the Measuring System



Warning:

- Only use the delivered power adapter, Mat. No. 43768.
- Observe the correct polarity when placing the batteries.
- Only use 1.5 V AA batteries or 1.2 V AA rechargeable batteries of the same type and charge condition.

1. Place two 1.2/1.5V AA batteries in the battery compartment at the rear of the instrument or connect the delivered power adapter.
2. If necessary, connect the sensor to the measuring cable (some sensors are supplied with non-detachable cable).
3. Plug the sensor cable into the socket with the designation "CH 1" on the front side of the instrument.

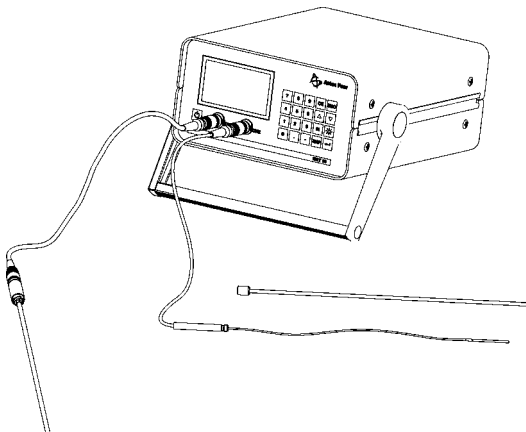

Fig. 6 - 1 TTI-22 with connected sensors

6.2 Putting the Measuring System into Operation

Press the <On/Off> key on the lower left front side of the instrument.

TTI-22 performs a self-test. If there are no errors, the instrument will enter measuring mode after the self test.

6.2.1 Getting Started with Pre-stored Sensor Parameters

If sensor parameters have already been entered and assigned to the sensor inputs 1 and 2 ex factory, TTI-22 displays the current temperature of the sensors.

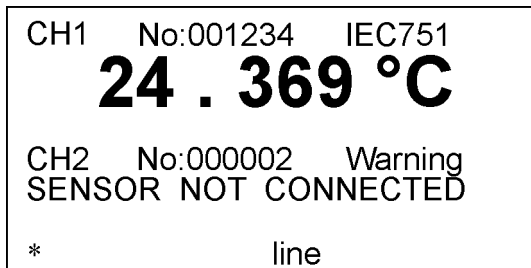

Fig. 6 - 2 Example for a measurement display

1. Before measuring with TTI-22, check if the displayed sensor numbers "No" match the numbers on the label positioned on the sensor.
2. Check if the entered and selected sensor parameters match the data on the factory or UKAS calibration certificate (see Chapter 7.5).

6.2.2 Getting Started without Stored Sensor Parameters

If no sensor parameters have been entered yet, TTI-22 displays no temperature:

```

CH1                               Warning
NO SENSOR CALIBRATION

CH2                               Warning
NO SENSOR CALIBRATION

                                line
    
```

Fig. 6 - 3 Display before input and/or selection of sensor parameters

You can either switch to the resistance display (see Chapter 7.6) or enter sensor parameters and assign these to sensor inputs 1 and 2:

1. Enter the sensor parameters according to the calibration certificate (see Chapter 7.5).
2. Assign the sensor parameters to the sensor input 1 (CH1) or 2 (CH2) (see Chapter 7.5)

TTI-22 displays the current temperature of the sensor:

```

CH1  No:001234  IEC751
    24 . 369 °C
CH2  No:000002  Warning
SENSOR NOT CONNECTED

*                                line
    
```

Fig. 6 - 4 Display after input and selection of sensor parameters

6.2.3 Switching TTI-22 Off

If you switch off TTI-22 with the <On/Off> key, the current operating condition (e.g. mean value mode for 20 values) is stored.

If you interrupt the power supply in another way, e.g. by pulling the plug, TTI-22 is deactivated without storing the current operating condition.

1. To switch off TTI-22, change to measuring mode.
2. Keep the <On/Off> key pressed for 1-2 seconds.

TTI-22 displays the message "Power down" and switches itself off.

7. Configuring TTI-22

After being switched on, TTI-22 is in measuring mode. Press the <M> key to change to the menu mode.

There are two ways to select a menu item:

- Use the arrow keys to move the cursor to the desired item and press the <↵> key.
- Enter the digit in front of the menu item.

If the display does not provide enough space for all lines in a menu, the symbol for the arrow key <▲> or <▼> appears on the right-hand side in the headline. You can scroll down the display with these arrow keys.

To go back to the next higher level, press the <ESC> key.

To change back to the measuring mode, press the <ESC> key in the main menu.

7.1 Setting a Password

TTI-22 has been assigned no password ex factory. We recommend setting a user password as soon as possible.

The user password restricts the access to the menus **Edit Configuration, Change User Password and LOCK/UNLOCK Device.**

To prevent unauthorized access to the menu, change to measuring mode before leaving the instrument or switch TTI-22 off.

If you have forgotten your user password, contact your Isotech representative.

Setting a user password

User Password
Old Password: ****
New Password: _

Fig. 7 - 1 Setting or changing the user password

1. Choose the menu **3 Change User Password.**
2. Enter the old user password ("Old Password").

When setting a password for the first time, enter "0000" in this line and confirm with <↵>.

3. Enter a new user password ("New Password").
4. To save the new password, press the <↵> key and select the answer "I YES" to the question "Save changes?".

7.2 Setting Date and Time

The date and time are set in order to check the validity of a calibration.

- Date format: "DD.MM.YYYY" (Day.Month.Year)
 - Time format: "HH.MM.SS" (Hour, Minute, Second)
1. To set the date and time, press the <M> key and switch to menu **2 Edit Configuration > 1 Clock**.
 2. Press the <↵> key in order to enter the date and time via the numerical keys.
 3. To change from day to month to year or to change from hour to minute to second, press the <←> key.
 4. To exit the menu, press <ESC> and answer the question "Save changes?" with "I YES".

7.3 Setting the Temperature Unit

To select the temperature display unit, switch to menu **2 Edit Configuration > 6 Units & Backlight** and set [°C], [K] or [°F].

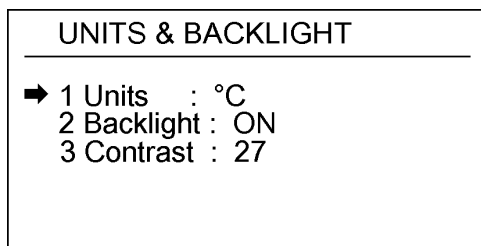

Fig. 7 - 2 Temperature unit

7.4 Setting Backlight and Contrast

- To set the backlight, switch to menu **2 Edit Configuration > 6 Units & Backlight > 2 Backlight**.

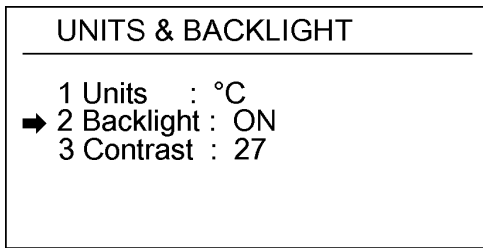

Fig. 7 - 3 Setting backlight and contrast

In this menu you can set the backlight to be automatically activated (ON) or deactivated (OFF) whenever TTI-22 is switched on.

During operation you can use the "Lamp" key to activate or deactivate the backlight at will.

- To set the contrast, select the menu item **3 Contrast** and press <←>. Each press of the key changes the contrast level by 1 step.

7.5 Entering Sensor Parameters and Assigning to a Sensor Inlet

TTI-22 measures the electrical resistance of the connected platinum sensors and uses it to calculate the temperature via internal formulas (standard case: quadratic equation).

These formulas' coefficients, which are different for each sensor, are called sensor parameters (or calibration parameters). Find these parameters in your calibration certificate.

Calibration parameters for up to 30 sensors can be stored in TTI-22.



Caution:

When performing a precise temperature measurement, only use calibrated sensors.

7.5.1 Entering or Changing Calibration Parameters for a Sensor

For each sensor you connect to the instrument you have to enter the calibration parameters according to the calibration certificate in order to measure temperatures.

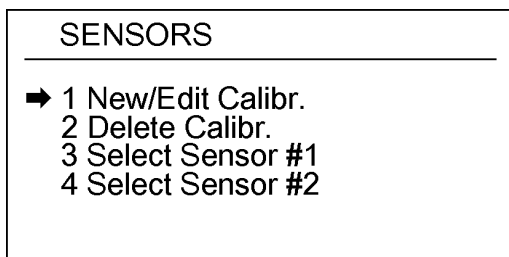

Fig. 7 – 4 Entering, deleting and assigning calibration parameters



Caution:

Make sure that you are using the correct calibration parameters for your sensors, since incorrect calibration parameters lead to erroneous results.

1. Before entering the calibration parameters, make sure that the date stored in TTI-22 is correct (see Chapter 7.2).

The date is stored together with the calibration parameters.

2. Switch to the menu mode and select the menu **2 Edit Configuration**.
3. Enter the user password and then select the menu item **3 Sensors > 1 New/Edit Calibr.**

The calibration parameters of up to 30 sensors can be entered. Initially all 30 lines display "----- Free".

In the example in Fig. 7 - 5 calibration parameters for several sensors have already been entered, with the sensor numbered "000001" having been assigned to channel 1 and the sensor numbered "125607" assigned to channel 2.

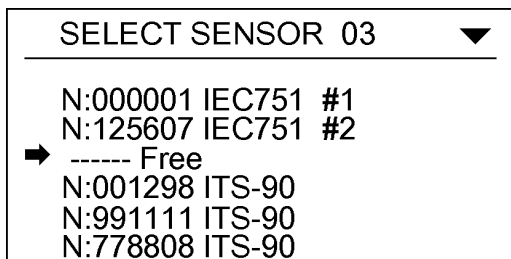

Fig. 7 - 5 Display of menu item

4. Select the first line displaying "----- Free" with the <←→> key.
5. Select the temperature calculation method and/or the temperature range (see Appendix D).

If the norm is not specified on the calibration certificate, you can use the calibration parameters on the calibration certificate for differentiation. With DIN IEC 751 the parameter R0 is always used, whereas with ITS-90 the parameter R(0.01 °C) is specified.

- For industry sensors, e.g. the sensors described in Appendix G, **select DIN IEC 751**.
 - For standard thermometers select one of the 11 ranges of **ITS-90**.
6. Enter the calibration number **Cal.No.** written on the sensor and in the calibration certificate.
 7. Enter a calibration time **Cal.Time** according to your experience and/or accuracy requirements.



Caution:

The calibration time mainly depends on the thermal stress on the platinum thermometer. This calibration time can only be estimated and is decided by the user. Therefore check your sensor including TTI-22 regularly (independent of the calibration time) and after major thermal stress at the triple point or freezing point of water. We recommend a yearly recalibration.

At the end of the calibration time the message "SENSOR CAL TIME" is displayed next to the channel in question. No temperature is displayed.

The overtime exceeding the validity limit of the calibration is displayed in the menu **New/Edit Calibr.** (e.g. "-14" means that the calibration has been invalid for 14 days).

In this case check the sensor either at a fixed point or by comparison calibration with a reference thermometer.

8. If you have selected DIN IEC 75, set the calibration temperature range (e.g. -50 to 200 °C; 0 to 420 °C, etc.) in the lines **Cal.Low** and **Cal.High**.
9. Enter the maximum sensor temperature in the line **Max.Temp**.

If the sensor producer has not stated the maximum temperature, choose one that is approx. 5°C above the upper limit (Cal.High) of the calibration temperature range.

Do not enter a value that is lower than the value entered for Cal.High. Otherwise the maximum temperature limit is not monitored.



Caution:

Exceeding the permissible operation temperature range can cause irreversible change in sensor behaviour and may require a new calibration.

10. Enter the calibration parameters (**R0, R[0.01 °C], A, B, C, C[1], ...C[5]**) according to the calibration certificate by overwriting the default values.

The number of parameters depends on the temperature range and the selected temperature calculation method.

In IEC-75 I the constant C is only used for temperatures below 0 °C. You can either set "C" to "0" or use the default value.

11. After you have concluded your input, press <ESC> and save the new values.

Example for a Pt 100 sensor:

Cal. No.: 000001
 Temp. Calculation: IEC-75 I
 Validity of calibration: 180 days
 Calibration temperature range: 0 - 200 °C
 Maximum sensor temperature: 250 °C
 R0 = 100.017
 A = 0.0039126
 B = -5.9153E - 7

After the example values have been entered, the display shows the following:

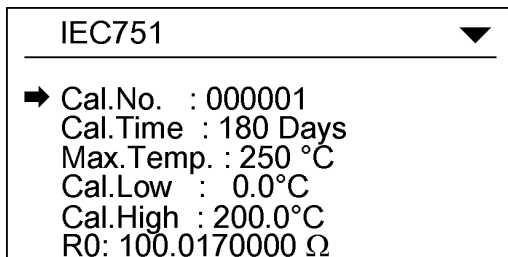

Fig. 7 - 6 Example for sensor data

After the maximum sensor temperature has been exceeded

1. Go to menu 3 Edit Configuration > 3 Sensors and select the item 1 New/Edit Calibration.

The calibration of an "overheated" sensor is marked with "Max.Temp" in the field "Cal.Time".

No temperature is displayed when this calibration is assigned to a sensor input, instead the message "Max Temp. exceeded" is shown.

In order to use the calibration again, enter a positive number at "Cal.Time".

2. Before continuing your work, at least check the sensor at the triple point or freezing point of water. The calibration parameters can only be used again if the deviation from the reference is within the permissible range.

In most cases a new sensor calibration will be necessary, which means you are provided new calibration parameters.

7.5.2 Assigning Calibration Parameters to a Sensor Channel

Assign a calibration to each of the two sensor channels (in menu 2 Edit Configuration > 3 Sensors > 3 Select Sensor #1 or 4 Select Sensor #2).



Information:

If you select the item "NO SENSOR Calibr." (the first line of the list on position 00) instead of a valid sensor calibration, you receive no displays of temperature, only resistance values are displayed.

7.5.3 Assigning Calibration Parameters to a Sensor Channel via PC/RS232

If you are using an external multiplexer or several calibrations for a sensor, you can assign a stored calibration to the desired sensor input via PC. The PC-navigated assignment is lost when the instrument is switched off. For connecting a PC, see Chapter 8.1.

To assign a calibration to a sensor input, send the command SET SEN1 XX/SET SEN2 XX (XX = 01, ..., 30).

In the example, calibration 01 is assigned to sensor input 1 and calibration 03 is assigned to the sensor input 2.

PC command	TTI-22 response
SET SEN1 XX (e.g. XX = 01)	SET SENSOR #1: 1
SET SEN2 XX (e.g. XX = 03)	SET SENSOR #2: 3

7.6 Selecting Display Type

To set the display type, go to menu 1 Sel. Display & Start and select one of the 6 display types.

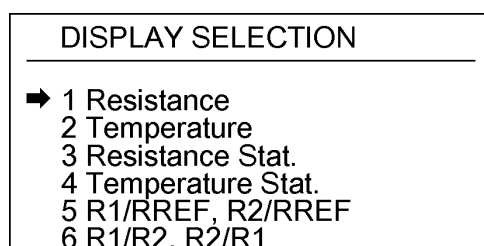

Fig. 7 - 7 Selecting the display type

After this selection TTI-22 automatically goes back into measuring mode.

1 Resistance

Display of ohmic resistance with four digits after the decimal point.

2 Temperature

Display of temperature with three digits after the decimal point.

3 Resistance Stat.

Display of resistance statistics: Display of current resistance, mean value and standard deviation of N previous values.

We recommend this display type for high-precision resistance measurements.

- Use the arrow keys to set the number N, the amount of values used for averaging, between 5 and 50.
- After each change to the number N it takes $N \times 1.44$ seconds until a new statistic is displayed (see Fig. 7 - 8).

CH1	109.43133 Ω
Mean :	109.43139 Ω
S.Dev:	0.00005 Ω
N:	05/05
CH2	109.56240 Ω
Mean :	109.56163 Ω
S.Dev:	0.00050 Ω
N:	05/05
	line

Fig. 7 - 8 Display of resistance statistic

The mean value and standard deviation are calculated using the following formulas:

Calculation of Mean:

$$Mean = R_{Mean} = \frac{1}{N} \times \sum_{i=1}^N R_i$$

Calculation of empirical standard deviation S. Dev.:

$$S.Dev. = \sqrt{\frac{1}{N-1} \times \sum_{i=1}^N (R_i - R_{Mean})^2}$$

The standard deviation is a measure of the short-term stability of the measuring values and should be lower than the expected measuring uncertainty.

4 Temperature Stat.

Display of temperature statistics: The current temperature is displayed with four digits after the decimal point; the mean value and the standard deviation are displayed with five.

We recommend this display type for high-precision temperature measurements.

5 RI/RREF, R2/RREF

Display of the ratios of sensor resistance to internal reference resistance.

6 RI/R2, R2/RI

Display of the ratios of one sensor resistance to the other.

7.7 Performing a Self-heating Test

The term self-heating relates to the sensor being heated by the measuring current. The measured temperature is therefore a bit higher than the temperature of the sample medium. Errors through self-heating of approx. 2mK and higher can be determined with the self-heating test.

Temperature changes of less than 0.5mK at operations with the lower measuring current are within TTI-22's measuring uncertainty and cannot be interpreted as self-heating.

Usually the self-heating of the sensor is considered in the calibration parameters. If the measuring current during calibration strongly deviates from the measuring current in TTI-22, or the thermal resistance (air, water, still or moving) strongly differs, this function is useful for avoiding major errors. The self-heating of sensors that are supposed to measure the temperature of still air, for example, is mostly already too significant to be ignored.

1. For the display select the temperature statistics (**1 Sel. Display & Start > 4 Temperature Stat.**).
2. Set $N > 20$ and note the average temperature $Temp_l$.
3. Use the digit key $<5>$ in the main menu to set **Self.Heat.Test to On**.

Now the measuring current is reduced times.

The lower right part of the display shows "SHT" for "Self Heating Test On"

4. Go back to the temperature statistics menu.
5. Note the average temperature $Temp_l / \div 2$ and calculate the temperature difference ($Temp_l - Temp_l / \div 2$).
6. Multiplying the determined temperature change by "2" gives you the current self-heating of the sensor.
7. For the actual measurement switch back to **Self.Heat.Test: Off**.

8. Reading out Measuring Data

You can transfer the measuring data to a PC. To do this, connect the PC to the RS232 interface of TTI-22 and use a terminal program or connect the PC to the Ethernet interface of TTI-22 and use a web browser.

8.1 Transferring Measuring Data via RS232

For transferring the data, connect the RS232 interface on the rear side of TTI-22 with the RS232 interface of the PC.

1. Connect the interfaces of TTI-22 and the PC with a data cable (e.g. a three-wire shielded cable with the lines TXD, RXD and GND).

PC - SERIAL PORT (9-PIN) RS232	TTI-22 RS232
1 Shield	
2 (RXD)	2 (TXD)
3 (TXD)	3 (RXD)
5 (GND)	5 (GND)

Fig. 8 - 1 Interface connection



Caution:

The instruments earlier TTI-22 features another interface connection with the wires 2 (RXD) and 3 (TXD) crossed. Therefore you cannot use the interface cable of these instruments for TTI-22 unless you use an adapter which crosses RXD and TXD. We recommend using the appropriate cable with the above specified interface connection (see Fig. 8 - 1).

2. Make sure that the interface parameters of TTI-22 and the PC match each other.
3. Configure the TTI-22 interface in the **menu 2 Edit Configuration > 4 RS232 Config.** as follows:

RS232 CONFIG.	
➔ 1 RS232	: ON
2 BaudRate	: 9600
3 DataBits	: 8
4 Parity	: NONE
5 Stopbits	: 1

Fig. 8 - 2 Interface setting

4. Select the same interface settings in the terminal program on your PC as you set for RS232.
5. To request data, use your terminal program to send the according command to TTI-22 (see Table 8.1).

Each command consists of two words followed by a <CR> character (carriage return, 13hex), e.g. "GET DATA <CR>". Make sure that you set your terminal program accordingly.

The response of TTI-22 consists of several lines separated by <CR> (carriage return) and <LF> (line feed) (see Table 8.1).

If you have entered an incorrect command, TTI-22 responds to the PC by sending back the available commands (see Appendix C.2).

Table 8.1: PC Commands

PC command	transferred data, examples
GET DATA	18.12.07 17:38:30 R1 = +125.02085 Ohm R2 = +109.00070 Ohm T1 = +64.6448 C T2 = +23.1107 C SENSOR1 = No:000002 SENSOR2 = No:000001
GET RREF	RREF Calibration: INT. RREF = 380.009068 CAL TIME (DAYS): 364
GET SENSOR	Sensor Calibrations: Sensor 1 = N:000002 IEC75 I CAL TIME (DAYS): 29 MAX TEMP[*C]: 990 CAL LOW[*C]: -300 CAL HIGH[*C]: 990 R0: 100.0000000 A: 0.00390802 B: -5.802000E-07 C: -4.273500E-12 Sensor 2 = N:000001 IEC75 I CAL TIME (DAYS): 29 MAX TEMP[*C]: 250 CAL LOW[*C]: 0 CAL HIGH[*C]: 200 R0: 100.0000000 A: 0.00390802 B: -5.802000E-07 C: -4.273500E-12

Table 8.1: PC Commands

PC command	transferred data, examples
GET CONFIG	Configuration: Software V1.000 18.12.07 17:43:03 RREF Calibration: INT. RREF = 380.009068 CAL TIME (DAYS): 364 Sensor 1 = N:007833 IEC75I CAL TIME (DAYS): 100 MAX TEMP[*C]: 800 CAL LOW[*C]: -50 CAL HIGH[*C]: 200 R0: 100.0000000 A: 0.00390830 B: -5.577500E-07 C: -4.183000E-12 Sensor 2 = N:007845 IEC75I CAL TIME (DAYS): 100 MAX TEMP[*C]: 800 CAL LOW[*C]: -50 CAL HIGH[*C]: 200 R0: 100.0000000 A: 0.00390830 B: -5.577500E-07 C: -4.183000E-12 Sensor 3 = N:000001 IEC75I CAL TIME (DAYS): 29 MAX TEMP[*C]: 250 CAL LOW[*C]: 0 CAL HIGH[*C]: 200 R0: 100.0000000 A: 0.00390802 B: -5.802000E-07 C: -4.273500E-12 Sensor 5 = N:000419 ITS-90 0-419*C CAL TIME (DAYS): 30 MAX TEMP[*C]: 990 CAL LOW[*C]: 0 CAL HIGH[*C]: 420 R.01: 100.0000000 A: 0.00030000 B: -9.000000E-04

Table 8.1: PC Commands

PC command	transferred data, examples
GET RSTAT	R1= 108.98370 Ohm Mean= 108.98418 Ohm S.Dev= 0.00026 Ohm R2= 125.02094 Ohm Mean= 125.02093 Ohm S.Dev= 0.00003 Ohm
GET TSTAT	SENSOR1= No:000002 T1= +23.0535 C Mean= 23.05659 C S.Dev= 0.00183 C SENSOR2= No:000001 T2= +64.6449 C Mean= 64.64503 C S.Dev= 0.00013 C
GET STATUS	TTI-22 atus MAC: 000DD9010764 Mains supply

8.2 Transferring Measuring Data via Ethernet

For data transfer connect the Ethernet interface (LAN) of TTI-22 to a local network.



Caution:

Be sure to only enter configuration parameters that fit the network you use. If necessary, contact the network administrator.

1. Configure the Ethernet interface at TTI-22 in the menu **2 Edit Configuration > 5 Ethernet Config** as follows:

ETHERNET CONFIG.

➔ WEBSERVER : ON
IP: 172.020.002.055
NM: 255.000.000.000
GW: 000.000.000.000

MAC: 000DD9010761

Fig. 8 - 3 Ethernet interface setting

The required IP address, Netmask (NM) and Gateway (GW) can be obtained from your network administrator.

The MAC address (Media Access Control) is the unique address of the instrument and was already entered ex factory.

2. To request data, enter the IP address in your browser.

The temperature and resistance values will be displayed. Currently no further functions are available.

9. Calibrating and Adjusting TTI-22

TTI-22 uses an internal reference resistor for measuring the electrical resistance of the sensor. The temperature value is calculated from the resistance measurement via internal formulas. For a precise temperature calculation a regular calibration/adjustment of TTI-22 and the used sensor is necessary.

Send TTI-22 to Isotech once a year for calibration/adjustment. For further information contact your local Isotech representative.

If you have the capacities for performing a calibration yourself, see Appendix E.

10 Locking Calibration Parameters

With a second password, the "Lock-Password", you can lock parts of the menu so that the relevant settings for the temperature measurement can no longer be manipulated. In this way, for example, standards bureau officers can lock TTI-22 for temperature measurements requiring official calibration.

After the Lock password has been entered, the menu items **1** to **3** in the submenu **2 Edit Configuration** are locked. Sensor parameters and reference resistor parameters and the time and date can no longer be altered.

Entering Lock password

1. Enter the user password.
2. Choose menu **4 LOCK Device**.
3. Enter a Lock password.

Now TTI-22 is locked. In the main menu **4 UNLOCK Device** is displayed.

In locked condition, the date, time, reference resistor parameters and sensor parameters can be accessed, but not altered.

4. To unlock TTI-22, select the menu **4 UNLOCK Device** and enter the Lock password. Now TTI-22 is unlocked. In the main menu **4 LOCK Device** is displayed.

Lock password forgotten

If you have forgotten the Lock password, contact your Isotech service engineer. This engineer can unlock TTI-22. Then you have to define a new Lock password.

II. Overview of the Menu Structure

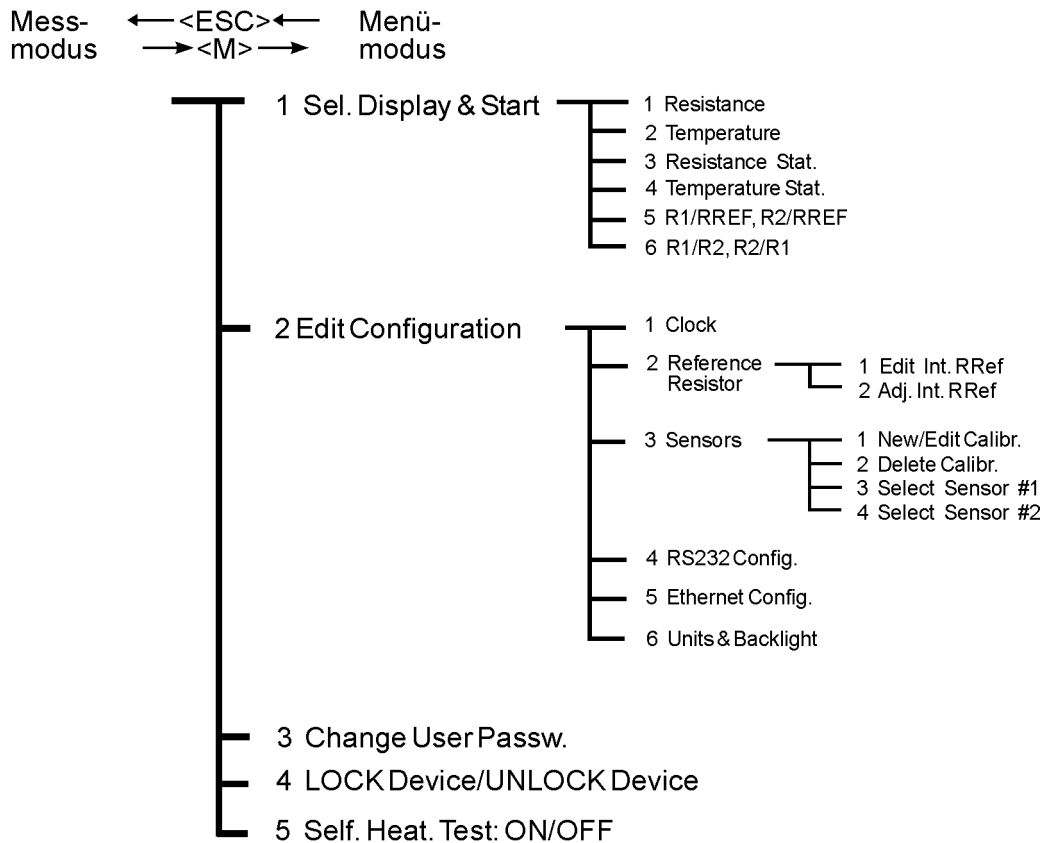

Fig. II - 1 Menu structure

II.1 Main Menu

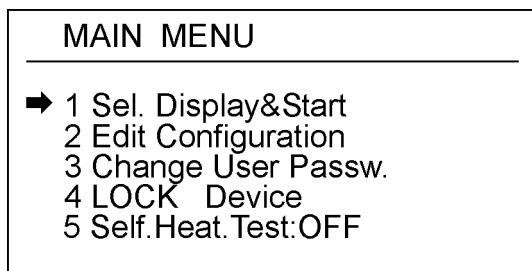

Fig. II - 2 Main menu

- 1 Sel. Display & Start** Display type selection.
- 2 Edit Configuration** Instrument parameter setting.
- 3 Change User Passw.** Entering/changing user password.
- 4 LOCK Device** Locking or unlocking TTI-22 with a "Lock Password".
- 5 Self.Heat.Test: OFF** Switching on/off the self-heating test.

11.2 Sel. Display & Start (Display Type Selection)

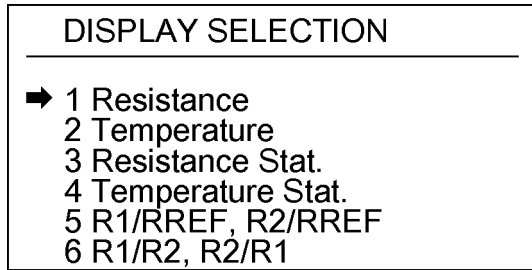

Fig. 11 - 3 Menu for display type selection

1 Resistance	Display of ohmic resistances with four digits after the decimal point
2 Temperature	Display of temperatures with three digits after the decimal point
3 Resistance Stat.	Display of resistance statistics: Display of resistances, mean values and standard deviations of the N last values. N can be set with the arrow keys.
4 Temperature Stat.	Display of temperature statistics: The current temperatures are displayed with four digits after the decimal point, the mean values and the standard deviations are displayed with five.
5 R1/RREF, R2/RREF	Display of the ratios of sensor resistance to reference resistance in large digits.
6 R1/R2, R2/R1	Display of the ratios of the two sensor resistances in large digits.

11.3 Edit Configuration

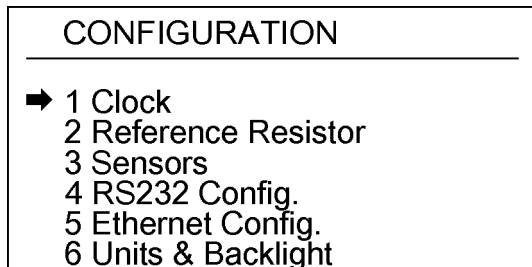

Fig. 11 - 4 Menu for setting the configuration

1 Clock	For setting the date and time. Date format "DD.MM.YYYY" (Day.Month.Year) Time format: "HH.MM.SS" (Hour, Minute, Second)
2 Reference Resistor	
1 Edit Int. RRef	For entering or changing the reference resistor value and the calibration time.
2 Adj. Int. RRef	Automatic calibration of the internal reference resistor.
3 Sensors	
1 New/Edit Calibr.	For entering or editing sensor parameters. Up to 30 calibrations can be stored in TTI-22.
Cal.No.	Calibration number.
Cal. Time	Calibration time in days: Period of a calibration's validity.
Max. Temp.	Maximum permissible temperature (if unknown, use Cal. High + 5 °C).
Cal. Low	Calibration temperature range.
Cal. High	
(only for IEC 751)	

R0, R.01	Calibration parameters: Resistance value at "0" or "0.01" °C, A, B, C coefficients of the used formulas
C[1], ... C[5]	
2 Delete Calibr.	For deleting sensor parameters.
3 Select Sensor#1	For assigning sensor parameters to a sensor input (CH1 or CH2).
4 Select Sensor#2	
4 RS232 Config.	Interface parameters of RS232.
5 Ethernet Config.	Parameters for the LAN interface.
6 Units & Backlight	
1 Units: °C/°F/K	For choosing degrees Celsius (°C), Kelvin (K) or degrees Fahrenheit (°F) as temperature display unit.
2 Backlight: OFF/ON	In this menu you can set the backlight to be automatically activated whenever TTI-22 is switched on. During operation you can use the "Lamp" key to activate or deactivate the backlight at will.
3 Contrast	For setting the contrast (20 ... 41).

Appendix A: Technical Data

The following specifications are related to an ambient temperature of +23 °C.

Find these terms explained in Basic Terms in Metrology 1319 Part 1-3.

A.1 TTI-22 as High-precision Resistance Meter

Internal reference resistance:	approx. 380 Ω
Resistance measuring range:	approx. 0-440 Ω
Resolution (0.1 ppm f.s. ^a):	40 $\mu\Omega$
Linearity error (< 1 ppm f.s.):	< 0.4 m Ω
Measuring uncertainty ^b : (confidence level: 95 %, Number of measuring values: 50)	< 0.4 m Ω

^a f.s. = full scales

^b This value does not include the calibration uncertainty of the used reference resistor.

A.2 TTI-22 as High-precision Thermometer (Specifications without Sensor)

	Pt 100, DIN IEC 751
Temperature measuring range: (depending on sensor)	-200 °C to 850 °C
Resolution:	0.1 mK
Linearity error (< 1 ppm f.s. ^a):	< 1 mK
Measuring uncertainty ^b : (confidence level: 95 %, Number of measuring values: 50)	< 1 mK
Sensor:	Platinum sensor up to a resistance of 440 Ω

^a f.s. = full scales

^b This value does not include the calibration uncertainty of the used reference resistor.

A.3 General Instrument Data

Measuring current (IDC):	0.5 mA
Measuring current (Ieff):	
Normal operation:	0.41 mA
During self-heating test:	$0.29 \text{ mA} \left(\frac{0.41}{\sqrt{2}} = 0,29 \right)$
Self-heating test on:	Measuring current/ $\div 2$
Measuring time:	1.44 seconds
(complete, for both channels)	
Internal reference resistor:	
Producer, type:	VISHAY, VHP 101
Temperature coefficient:	< 0.3 ppm/°C (+15 to +25 °C)
Stability without strain (producer information):	5 ppm max. dR after 1 year 10 ppm max. dR after 3 years
Display:	Liquid Crystal Display, graphic, with LED backlight 128 64 points (approx. 6.5 * 3.5 cm)
Keyboard:	20 keys
Number of sensor inlets (channels):	2
Sensor connections:	two Lemos sockets size IS304, four-pole
Data outlets:	RS232 D (9-pole D-Sub outlet) LAN/Ethernet (RJ 45 plug)
Ambient conditions:	0 -35 °C, no direct exposure to sunlight < 90% air humidity, non-condensing
Warm-up time:	60 minutes
Power supply:	
Batteries/rechargeables:	2x 1.2-1.5 V AA
or power adapter (Mat. No. 43768):	Input: AC 100 - 240 V, 50 - 60 Hz, 2 W Output: DC 7.5 V, 250 mA
Dimensions (L x W x H):	240 x 190 x 110 mm
(without handle)	
Weight	approx. 2 kg

Appendix B: Declaration of Conformity



Anton Paar GmbH hereby declares that the product listed below in the version offered for sale meets all the basic requirements of the applicable sections of the relevant EU directives in design and type.

This declaration will be deemed invalid should any unauthorized modifications be made to the product. Follow the information given in the instruction manual when setting up and operating the instrument.

Product designation: **TTI-22 Precision Thermometer**
Model: **TTI-22**
Manufacturer: **Anton Paar GmbH**

The product meets the requirements of the following directives:

- **Electromagnetic Compatibility 2004/108/EC**

Applied standards:

EN 61326-1:2006

Electrical equipment for measurement, control and laboratory use - EMC requirements - Part 1: General requirements

The product is classified as a class B equipment and is not intended for the use in industrial area.

- **Low Voltage Directive 2006/95/EC**

Applied standards:

EN 61010-1:2001

Safety requirements for electrical equipment for measurement, control and laboratory use
Part 1: General requirements

A handwritten signature in blue ink, appearing to read "Dr. Friedrich Santner".

Dr. Friedrich Santner
General Manager

A handwritten signature in blue ink, appearing to read "Dipl. Ing. Gerhard Murer".

Dipl. Ing. Gerhard Murer
Department Manager

Appendix C: Troubleshooting

C.1 TTI-22 Error Messages

If errors occur during TTI-22 operation, an error message is displayed.

Error message	Cause	Correction
"ADC ERROR OUT OF RANGE"	The sensor is damaged or the TTI-22 ADC is defective.	Contact your Isotech representative or apply a different sensor.
"CALIBRATION RANGE"	<ul style="list-style-type: none"> The sensor parameters were entered incorrectly or with a wrong algebraic sign. The temperature range entered (IEC751) or selected (ITS-90) at the sensor parameters was underrun or overrun. 	<ul style="list-style-type: none"> Check the entered parameters. Assign another calibration with appropriate temperature range to the sensor channel.
"MAX TEMP EXCEEDED"	The sensor was heated to a temperature higher than the maximum entered in the calibration data. "Max.Temp." is displayed in the line "Cal.Time".	Calibrate the sensor again and enter the new calibration parameters.
"NO SENSOR CALIBRATION"	No sensor parameters were assigned to the channel.	Assign sensor parameters to the channel.
"RREF CAL. TIME"	The calibration time of the reference resistor is over. A negative digit is displayed in the line "Cal.Time".	Calibrate the reference resistor and enter a positive digit at "Ref:CALTIME".
"SENSOR CAL. TIME"	The calibration time of the selected sensor is over. A negative digit is displayed in the line "Cal.Time".	Calibrate the sensor and enter the new calibration parameters (including the calibration time).
"SENSOR NOT CONNECTED"	No sensor was connected to the sensor channel.	Connect a sensor.
"WRONG RREF SELECTION"	The actual value of the reference resistor differs too much from the entered value.	Calibrate TTI-22 again and enter a precise value.

C.2 PC Error Messages

If TTI-22 is connected to a PC via RS232 interface and data is read out with a terminal program, the PC may receive the following error messages.

Error message	Cause	Correction
??? UNKNOWN COMMAND COMMANDS: GET DATA GET RREF GET SENSOR GET CONFIG GET RSTAT GET TSTAT GET STATUS SET SEN1 SET SEN2	The entered command was not recognized.	Be sure to use the correct syntax.

After entering "GET RSTAT" or "GET TSTAT":

"Too few samples"	The mean and standard deviation values are directly requested after starting up TTI-22 or after changing the number "N" before the number of measuring values "N" is reached	Wait $N \times 1.44$ seconds before reading out the result.
"wrong display mode selected"	TTI-22 is not in the correct statistics display mode.	Set the correct display mode.

When choosing a sensor calibration with the command "SET SEN1 XX" or "SET SEN2 XX":

"invalid memory number"	A value outside the range from 1 to 30 was entered as XX.	To choose a calibration, use the correct syntax "SET SEN1 XX" or SET SEN2 XX" (XX = 01, ..., 30).
"no calibration data"	There is no data for the selected sensor calibration.	Choose a different sensor calibration or extend the calibration data of the chosen sensor calibration.
"too few parameters for SET SEN"	The XX value has not been entered.	To choose a calibration, use the correct syntax "SET SEN1 XX" or SET SEN2 XX" (XX = 01, ..., 30).
"RI = not valid"	Answer to the command "Get Data" if the calibration of the internal reference resistor has expired.	Adjust the internal reference resistor.
"TI = not valid"	Answer to the command "Get Data" if the calibration of the measuring sensor has expired or the maximum temperature has been exceeded.	Renew the calibration of the sensor.

C.3 Problems with Instrument Activation

If TTI-22 cannot be switched on or immediately switches itself off again after activation, check the following:

1. If you operate TTI-22 with batteries/rechargeables, check their charge condition.
2. If you operate TTI-22 with a power adapter, check whether the power adapter is correctly plugged in.
3. If the instrument immediately switches itself off despite functional power supply, check the sensors:
 - Disconnect the sensors from TTI-22.
 - Switch on the instrument.

If it is switched on without problems, the error is caused by a defect of the sensor or sensor cable.

- Repair the sensors or sensor cables or exchange them.

Appendix D: Temperature Calculation Methods

TTI-22 employs two methods for calculating the temperature from the primarily measured property "ohmic resistance": The DIN IEC 751, which describes the relation between resistance and temperature for industrial sensors, and the ITS-90 (International Temperature Scale 1990), the temperature scale valid for standard thermometers since 1990.

D.1 DIN IEC 751: Industrial Platinum Resistance Thermometers and Platinum Measuring Resistors

The DIN IEC 751 defines requirements for industrial platinum resistance thermometers whose electrical resistance is a defined function of the temperature. It is valid for platinum thermometers in the temperature range of -200 °C to +850 °C.

Basic values

The relation between electrical resistance and temperature is defined as follows:

Range -200 °C to 0 °C:

$$\text{(Equ. 1)} \quad R_t = R_0[1 + At + Bt^2 + C(t - 100 \text{ °C})t^3]$$

Range 0 °C to 850 °C:

$$\text{(Equ. 2)} \quad R_t = R_0(1 + At + Bt^2)$$

Constants:

$$A = 3.9083 \times 10^{-3} \text{ °C}^{-1}$$

$$B = -5.775 \times 10^{-7} \text{ °C}^{-2}$$

$$C = -4.183 \times 10^{-12} \text{ °C}^{-4}$$

Variables:

t.....Temperature in °C

R_t...Resistance at temperature t

R₀...Resistance at 0°C

The basic values for platinum resistance thermometers are calculated from the equations (1) or (2).

Nominal values

The nominal value for platinum resistance thermometers usually is 100 Ω (at 0 °C).

Limiting deviations

Two classes of resistance thermometers are discerned based on their limiting deviations:

Class	Limiting deviations in °C
A	$0.15 + 0.002 * t ^a$
B	$0.3 + 0.005 * t $

^a |t| ...Absolute numerical value of the temperature in °C

Thermometers with a nominal value of 100 Ω have to be classified based on the limiting deviations.

Class A cannot be used for Pt 100 above 650 °C and thermometers with 2-wire connection of the sensor.

Calibration of industrial platinum resistance thermometers

The equations and constants defined in DIN IEC 751 are used to classify sensors with regard to their highest permissible deviations. In this way, DIN sensor replacement without any on-site calibration is possible.

Uncalibrated sensors are not suitable for high-precision temperature measurements – at 0 °C they already feature an allowed deviation of several tenths of degrees Celsius.

Thus, new solutions were called for. Based on many years of experience, it was found that industrial sensors with a considerably higher accuracy (10mK) over a wide temperature range can be produced and calibrated.

To achieve this accuracy, the sensors have to be compared to reference thermometers at three or four certain temperatures. The equation used in DIN IEC 751 for determining the basic values is then set to these measuring points. This gives individual parameters R_0 , A, B and/or C for each sensor.

Example:

You require a platinum resistance thermometer for the range of 0-200 °C. The thermometer is compared to a high-precision reference thermometer at 0 °C, 100 °C and 160 °C. With the three measuring points and the equation

$$R_t = R_0[1 + At + Bt^2]$$

the parameters R_0 , A and B are determined.

For calibration plausibility the calibrated platinum resistance thermometer is compared to the reference thermometer at 60 °C too. From the correlation of the temperatures at this point the measuring uncertainty of the thermometer between the calibration points can be determined.

A sensor calibrated in this manner together with a TTI-22 can achieve measuring uncertainties of < 10mK in the calibrated range.

The total measuring uncertainty largely depends on the calibration of the sensor; the measuring uncertainty of the high-precision thermometer TTI-22 is negligible.

D.2 International Temperature Scale 1990 (ITS-90)

11 temperature ranges of ITS-90 are implemented in the instrument. Find further details on this temperature scale in technical literature.

Table 11.1: Calibration points and parameters for the temperature ranges 1 through 4 (in K) (T ... triple point)

Temperature range [K]		Calibration points	Parameters
1	13,8033 - 273,16	TH ₂ , TNe, TO, TH _g , TH ₂ O ^a	a, b, c ₁ , c ₂ , c ₃ , c ₄ , c ₅
2	24,5561 - 273,16	TH ₂ , TNe, TO, TAr, TH _g , TH ₂ O	a, b, c ₁ , c ₂ , c ₃
3	54,3584 - 273,16	TO, TAr, TH _g , TH ₂ O	a, b, c ₁
4	83,8058 - 273,16	TAr, TH _g , TH ₂ O	a, b

a.. and additional temperatures close to 17 K and 20.3 K

Table II.2: Calibration points and parameters for the temperature ranges 5 through 11 (in °C) (T ... triple point, E ... freezing point, S ... melting point)

Temperature range [°C]		Calibration points	Parameters
5	0 - 961,78	TH ₂ O, ES _n , EZ _n , EAl, EAg	a, b, c, d (d = 0 for T ₉₀ < 660.323 °C), W (660 °C)
6	0 - 660,32	TH ₂ O, ES _n , EZ _n , EAl	a, b, c
7	0 - 419.527	TH ₂ O, ES _n , EZ _n	a, b
8	0 - 231.928	TH ₂ O, El _n , ES _n	a, b
9	0 - 156.5985	TH ₂ O, El _n	a
10	0 - 29.7646	TH ₂ O, SGa	a
11	-38.8344 - 29.7646	THg, TH ₂ O, SGa	a, b

Appendix E: Calibrating and Adjusting TTI-22

E.1 Calibrating and Adjusting TTI-22

During calibration the displayed temperature value or resistance value is compared to the display of an accurate reference thermometer or reference resistor. The deviation from the reference is determined.

During the adjustment the instrument parameters are set in such a way that the deviation from the reference is as small as possible.

Caution:

The absolute accuracy of the resistance/temperature measurement depends on the calibration and subsequent adjustment of TTI-22.

- Therefore only let well-trained staff or an authorized institute perform the calibration and adjustment.
- Record each calibration and adjustment in writing and file these records with care.

The highly stable high-precision resistor VHP 101 from the company VISHAY is installed as internal reference resistor in TTI-22. Its specifications are as follows:

- Long-term stability at storage conditions: 5 ppm per year (1 % A.Q.L.)
- Temperature coefficients of the resistor: < 0.3 ppm/°C (-55 to 125 °C)

The internal reference resistor is barely strained during laboratory use, neither thermally nor electrically (dissipation loss 100 μW). So these are practically storage conditions.

Caution:

Before the instrument is delivered, the value of the internal reference resistor is determined to four digits after the decimal point and is stored in the instrument. To ensure the absolute accuracy of the resistance/temperature measurement, do not change the numerical value of the reference resistor without prior recalibration.

Determining suitable calibration intervals

If the true value of the reference resistor deviates from the value stored in TTI-22, this will result in a gain error of the resistance measurement in the used measuring model. If the deviation is 3 ppm, for example, the additional deviation of the sensors' resistance display also is 3 ppm.

The resulting systematic deviation of the temperature display approximately stems from the absolute error of the resistance display divided by 0.1 mOhm/mK (Pt 25) or 0.4 mOhm/mK (Pt 100). Therefore this systematic deviation of the temperature display depends on the range.

Calculation example:

Measuring instrument:	TTI-22, RRef = approx. 380 Ω, max. aging per year 5ppm
Sensor:	Pt 100, R1 = 100 Ω (relates to approx. 0 °C)
Relative deviation of the resistance display:	5 ppm
Absolute deviation of the resistance display:	5 ppm * 100 Ω = 0.5 m Ω
Resulting deviation of the temperature display:	0.5 m Ω / (0.4 m Ω / mK) = 1.25mK (after 1 year)

If the additional systematic deviation throughout the entire measuring range is supposed to be smaller than 1mK, the change of the reference resistance can amount to a maximum of 1ppm. The internal reference resistor has to be calibrated every two months.

In case of a limited measuring range or a lower accuracy requirement, the calibration intervals can be increased accordingly. After the repeated calibration of the internal reference resistor over a period of 1 to 2 years its behaviour can be predicted with great accuracy.

Performing an automatic adjustment

You can adjust the internal reference resistor very easily by connecting an exactly known, certified standard resistor and determining the new value of the internal reference resistor.

Equipment:

- TTI-22
 - Standard resistor [100 Ohm or rather 400 Ohm]
 - Calibration certificate for the standard resistor certified by a bureau of standards [measuring uncertainty < 1 ppm]
 - Thermostat with oil bath
1. The standard resistor in the oil bath needs to be brought to the reference temperature stated in the calibration certificate.
 2. Connect the standard resistor to sensor channel 1.
 3. Select the menu item **2 Edit Configuration > 2 Reference Resistor > 2 Adj. Int. RRef.**

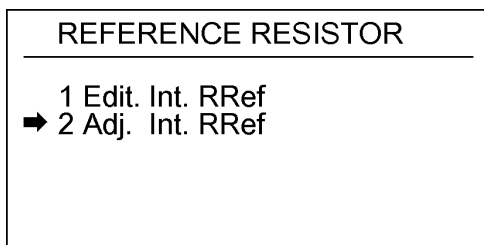

Fig. E – 1 Adjusting reference resistor

4. At **Std. Res** enter the standard resistor value according to the calibration certificate.
5. Now press the <←> key.
6. Wait approx. 1.5 minutes (50 measuring values).

The newly determined value of the internal reference resistor **New Rref** as well as the old value **Old Rref** appear on the display.

7. Note the old and the new reference resistor values and the current date.
8. File these records with care.
9. To continue, press the <←> key.
10. Press the <←> key again in order to store the new value for the internal reference resistor.

The calibration time **Cal.Time** is automatically set to 100 days. You can individually customize the calibration time.



Caution:

The calibration time can only be estimated. Therefore it is your own responsibility to perform regular checks of the measuring device at the triple point or freezing point of water.

After the adjustment, perform another calibration to check TTI-22 as follows:

11. Choose menu **I Sel. Display & Start > 3 Resistance Stat.**
12. Use the **<▲>** key to set the amount of values N, with which the mean value is calculated, to 50.
13. Wait approx. 1.5 minutes.
14. Check if the displayed mean value of the standard resistor accords with the mean value stated in the calibration certificate.

The two values shall at most differ by the measuring uncertainty of TTI-22.

Performing a manual adjustment

For a manual adjustment, as opposed to the automatic one, you need to calculate the new value of the internal reference resistor and enter it into TTI-22 yourself.

The following formula is used for the calculation:

$$R_{Ref[new]} = R_{Ref[old]} \times \frac{R_{ext}}{R_{an}} \quad (\text{Equ. 3})$$

$R_{Ref[new]}$	calculated value of the internal reference resistor in Ω
$R_{Ref[old]}$	value of the internal reference resistor stored in TTI-22 in Ω
R_{ext}	value of the externally connected standard resistor in Ω according to calibration certificate
R_{an}	mean value of the external standard resistor displayed on TTI-22 (amount of the measuring values used for averaging: N=50)

Equipment:

- TTI-22
 - Standard resistor [100 Ω or 400 Ω]
 - Calibration certificate for the standard resistor certified by a bureau of standards [measuring uncertainty < 1 ppm]
 - Thermostat
1. Find the value for $R_{Ref[old]}$ in the menu **2 Edit Configuration > 2 Reference Resistor > I Edit Int. RRef.**
 2. Find the value R_{ext} in the calibration certificate of the standard resistor.
 3. To determine the value R_{an} , the standard resistor in the thermostat needs to be brought to the reference temperature stated in the calibration certificate.
 4. Connect the standard resistor to sensor channel I.
 5. Choose menu **I Sel. Display & Start > 3 Resistance Stat.**

6. Use the <▲> key to set the amount N, with which the mean value is calculated, to 50.
7. After approx. 1.5 minutes, read the mean value R_{an} from the display.
8. Insert the determined values in the formula and in this way calculate the new value of the internal reference resistor $R_{Ref}[new]$.
9. Save the new value of the reference resistor in TTI-22 via the menu **2 Edit Configuration > 2 Reference Resistor > 1 Edit Int. RRef.**
10. Now check if the displayed mean value of the external standard resistor accords with the mean value stated in the calibration certificate.
11. Note the date, measuring medium and $R_{Ref}[new]$ in a measuring protocol and file it with care.

Example:

$R_{Ref[old]}$ (stored in TTI-22)	= 400.003 Ω
R_{ext} (value of the externally connected standard resistor according to calibration certificate)	= 100.014 Ω
R_{an} (displayed value on TTI-22)	= 100.0185 Ω

As this shows, the displayed value deviates from the actual value stated in the calibration certificate. Insertion in Equ. 3 gives:

$$R_{Ref[new]} = 400.003 \times \frac{100.014}{100.0185} = 399.9850 \Omega$$

After the new value 99.9985 Ω has been entered for RRef, the mean value displayed on TTI- 22 has to match the actual value of the standard resistor.

Otherwise repeat the procedure.

E.2 Calibrating and Adjusting the Sensor

You can calibrate and adjust sensors by connecting a known, certified reference sensor and your un-adjusted sensor to a TTI-22 unit and in this way determining the value of the sensor resistance using a highly precise thermostat at various temperatures. With equations of DIN IEC 751 or ITS-90 you can calculate the sensor parameters.

Equipment:

- TTI-22 (adjusted)
- Reference sensor with calibration certificate
- Un-adjusted sensor
- Thermostat

1. Connect the reference sensor to sensor channel 1.
2. Connect the un-adjusted sensor to sensor channel 2.
3. Select the display type **Resistance Stat.**
4. Read the values for the resistance.
5. Calculate the coefficients with the according formula.
6. Record the calibration and adjustment data in writing and file these records with care.
7. Enter the newly calculated coefficients for your sensor into TTI-22 and assign these calibration parameters to a sensor input.

Appendix F: Converting the Temperature Unit

To convert the temperature into different units, use the following conversion equations:

Conversion of degrees Fahrenheit:

$$T[K] = \frac{5}{9} \cdot (\delta[{}^{\circ}F] - 32) + 273.15$$

$$t[{}^{\circ}C] = \frac{5}{9} \cdot (\delta[{}^{\circ}F] - 32)$$

Conversion of Kelvin:

$$\delta[{}^{\circ}F] = \frac{9}{5} \cdot (T[K] - 273.15) + 32$$

$$t[{}^{\circ}C] = T[K] - 273.15$$

Conversion of degrees Celsius:

$$T[K] = t[{}^{\circ}C] + 273.15$$

$$\delta[{}^{\circ}F] = \frac{9}{5} \cdot t[{}^{\circ}C] + 32$$

T[K] Temperature in K

t[$^{\circ}$ C] Temperature in $^{\circ}$ C

d[$^{\circ}$ F] Temperature in $^{\circ}$ F

Appendix G: Firmware Versions

Firmware Version	Date of Release	Document Number	Comment
VI.000	17.12.2007	A911B04A	First firmware version released
VI.030	18.06.2008	A911B04B	Minor changes
		A911B04C	Minor changes for DMA M
VI.15	21.10.2009	A911B04D	<ul style="list-style-type: none"> • Improved approximation methods for DIN IEC 75 I calculations • Improved data transfer via RS232
VI.97	10.06.2010	A911B001EN-A	<ul style="list-style-type: none"> • Improved Web-Interface (LAN) • XML page available (LAN) • 8 digits serial numbers for sensors • 8 digits device serial numbers introduced • New PC commands for DIN IEC 75 I sensor definitions • More decimal places for the resistance and temperature means • New features in statistics display: switch to big digits for mean and temporary display of sensor number
		A911B001EN-B	<ul style="list-style-type: none"> • Direct connection to a PC • New sensors
V2.04	09.07.2013	A911B001EN-C A911B001EN-D	<ul style="list-style-type: none"> • ITS-90: 2 auto-switch ranges available • New PC commands • Modified menu structure • Polynomial of 4th order (new sensor type: approximation by a standard polynomial)

Declaration of Conformity

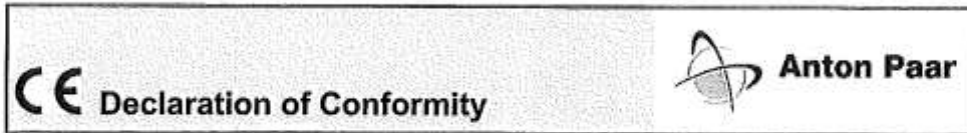

Anton Paar GmbH hereby declares that the product listed below in the version offered for sale meets all the basic requirements of the applicable sections of the relevant EU directives in design and type.

This declaration will be deemed invalid should any unauthorized modifications be made to the product. Follow the information given in the instruction manual when setting up and operating the instrument.

Product designation: **TTI-22 Precision Thermometer**
Model: **TTI-22**
Manufacturer: **Anton Paar GmbH**

The product meets the requirements of the following directives:

- **Electromagnetic Compatibility 2004/108/EC**

Applied standards:

EN 61326-1:2006

Electrical equipment for measurement, control and laboratory use - EMC requirements - Part 1: General requirements

The product is classified as a class B equipment and is not intended for the use in industrial area.

- **Low Voltage Directive 2006/95/EC**

Applied standards:

EN 61010-1:2001

Safety requirements for electrical equipment for measurement, control and laboratory use
Part 1: General requirements

A handwritten signature in black ink, appearing to read "Dr. Friedrich Santner".

Dr. Friedrich Santner
General Manager

A handwritten signature in black ink, appearing to read "Dipl. Ing. Gerhard Murer".

Dipl. Ing. Gerhard Murer
Department Manager