

PEGASUS^{PLUS} 1200



Isotech North America
158 Brentwood Drive, Unit 4
Colchester, VT 05446

Phone: (802)-863-8050
Fax: (802)-863-8125

www.isotechna.com
sales@isotechna.com

The company is always willing to give technical advice and assistance where appropriate. Equally, because of the programme of continual development and improvement we reserve the right to amend or alter characteristics and design without prior notice. This publication is for information only.

]

CONTENTS



<u>PAGE</u>	<u>DESCRIPTION</u>
3,4	EMC Information
5	Health & Safety Instructions
6	Guarantee
7	Cautionary Note
8	Introduction
9,10	Unpacking & Initial Inspection
11,12	Specification
13,14	Assembling the Insert
15	Operating the Controller
16,17,18,19	Operating the Indicator
20,21	Connecting a Current Transmitter (up to 20mA)
22	Using the PC Interface
23,24	Using Cal Notepad
25	Diagnostics (Error Messages)
26,27	Pegasus ^{Plus} 1200S, 1200B - Initial Testing
28	Pegasus ^{Plus} 1200S, 1200B - Maintenance
29	Operating Procedures
30	Pegasus ^{Plus} 1200B, 1200S - Checking Using the Temperature Indicated on the Controller
31	Pegasus ^{Plus} 1200B, 1200S - Calibration Using a Standard Thermometer with External Indication
32	Pegasus ^{Plus} 1200 S - Calibration Using a Standard Thermometer and the Internal Indicator
33	Pegasus ^{Plus} 1200S - Calibration Using the Internal Indicator to Read a Standard and Unknown Thermometers
34	Pegasus ^{Plus} 1200S - Using the Indicator to Measure Temperatures Remote from the Furnace
35	Figure 1
36	Figure 2
37	Appendix 1 - Trouble Shooting
38	Appendix 2 - Accessories
39,40	Appendix 3 - Indicator Configuration
A - L	Metal Block Tutorial



EMC INFORMATION

This product meets the requirements of the European Directive on Electromagnetic Compatibility (EMC) 89/336/EEC as amended by EC Directive 92/31/EEC and the European Low Voltage Directive 73/25/EEC, amended by 93/68/EEC. To ensure emission compliance please ensure that any serial communications connecting leads are fully screened.

The product meets the susceptibility requirements of EN 50082-1, criterion B.

Symbol Identification	Publication	Description
	ISO3864	Caution (Refer to Handbook)
	IEC 417	Caution, Hot Surface
		

ELECTRICAL SAFETY

This equipment must be correctly earthed.

This equipment is a Class 1 Appliance. A protective earth is used to ensure the conductive parts can not become live in the event of a failure of the insulation.

The protective conductor of the flexible mains cable which is coloured green/yellow **MUST** be connected to a suitable earth.

The blue conductor should be connected to Neutral and the Brown conductor to Live (Line).

Warning: Internal mains voltage hazard. Do not remove the panels.

There are no user serviceable parts inside. Contact your nearest Isotech agent for repair.

Voltage transients on the supply must not exceed 2.5kV.

Conductive pollution, eg. Carbon dust, must be excluded from the apparatus. EN61010 pollution degrees 2.

The apparatus has two input connectors for temperature sensors, see Figure 1. These inputs are only suitable for either a thermocouple or resistance thermometer. No other sensor or signal may be connected.



HEALTH AND SAFETY INSTRUCTIONS

1. Read all of this handbook before use.
2. Wear appropriate protective clothing.
3. Operators of this equipment should be adequately trained in the handling of hot and cold items and liquids.
4. Do not use the apparatus for jobs other than those for which it was designed, ie. the calibration of thermometers.
5. Do not handle the apparatus when it is hot (or cold), unless wearing the appropriate protective clothing and having the necessary training.
6. Do not drill, modify or otherwise change the shape of the apparatus.
7. Do not dismantle the apparatus.
8. Do not use the apparatus outside its recommended temperature range.
9. If cased, do not return the apparatus to its carrying case until the unit has cooled.
10. There are no user serviceable parts inside. Contact your nearest Isotech agent for repair.
11. Ensure materials, especially flammable materials are kept away from hot parts of the apparatus, to prevent fire risk.

GUARANTEE

This instrument has been manufactured to exacting standards and is guaranteed for twelve months against electrical break-down or mechanical failure caused through defective material or workmanship, provided the failure is not the result of misuse. In the event of failure covered by this guarantee, the instrument must be returned, carriage paid, to the supplier for examination and will be replaced or repaired at our option.

**FRAGILE CERAMIC AND/OR GLASS PARTS ARE NOT COVERED BY THIS
GUARANTEE**

**INTERFERENCE WITH, OR FAILURE TO PROPERLY MAINTAIN THIS INSTRUMENT
MAY INVALIDATE THIS GUARANTEE**

RECOMMENDATION

The life of your **ISOTECH** Instrument will be prolonged if regular maintenance and cleaning to remove general dust and debris is carried out.

We recommend the Pegasus Site to be re-calibrated annually.

Serial No:.....

Date:.....



Isotech North America
158 Brentwood Drive, Unit 4
Colchester, VT 05446

Phone: (802)-863-8050
Fax: (802)-863-8125

www.isotechna.com
sales@isotechna.com

The company is always willing to give technical advice and assistance where appropriate. Equally, because of the programme of continual development and improvement we reserve the right to amend or alter characteristics and design without prior notice. This publication is for information only.



CAUTIONARY NOTE

ISOTECH PRODUCTS ARE INTENDED FOR USE BY TECHNICALLY
TRAINED AND COMPETENT PERSONNEL FAMILIAR WITH
GOOD MEASUREMENT PRACTICES.

IT IS EXPECTED THAT PERSONNEL USING THIS EQUIPMENT
WILL BE COMPETENT WITH THE MANAGEMENT OF APPARATUS
WHICH MAY BE POWERED OR UNDER EXTREMES OF TEMPERATURE,
AND ARE ABLE TO APPRECIATE THE HAZARDS WHICH MAY
BE ASSOCIATED WITH, AND THE PRECAUTIONS TO BE TAKEN WITH,
SUCH EQUIPMENT.

INTRODUCTION

The Pegasus^{Plus} 1200 series consists of two models, the Basic (B) and Site (S). Both models have been designed to be rugged and easily maintained.

By using a proprietary plug-in controller the total electronics package can be replaced in a few minutes. As can be seen from the parts list, remarkably few components have been used, each of which are easily removed and replaced. All models have a temperature range of 150 to 1200°C.

Pegasus^{Plus} 1200 B - see page 33

This model provides an isothermal enclosure (metal block) in which thermometers and thermostats can be checked against the temperature indicated on the temperature controller.

For traceable calibration a standard (reference) probe should be placed into the metal blocks alongside the units under test.

The probe under test should be calibrated by comparison to the standard probe.

Pegasus^{Plus} 1200 S - see page 34

The S is again similar to the B but this unit has the addition of a digital temperature indicator. The indicator is independent from the controller and can be programmed to work with a thermocouple or industrial Pt 100 resistance thermometer.

This combination of sensor and probe can be calibrated. Then the units under test can be compared to the independent calibrated measuring systems allowing for traceable calibration.

The Pegasus^{Plus} 1200 Series represents the third generation of a ten year development program. During which many customer improvement suggestions have been incorporated into the models. Such suggestions have generally arisen from technical queries posed by equipment users, therefore please consult with us if at all unsure with any aspect of our equipment.

The Pegasus^{Plus} 1200 models are part of a range of portable calibrators designed and made by ourselves. Please contact us if you require more information about our other products.

UNPACKING AND INITIAL INSPECTION

Our Packing Department uses custom designed packaging to send out your unit, but as accidents can still happen in transit, you are advised, after unpacking the unit, to inspect it for any sign of shipping damage, and confirm that your delivery is in accordance with the packing note. If you find any damage or that part of the delivery is missing notify us or our agent, and the carrier immediately. If the unit is damaged you should keep the packing for possible insurance assessment.

ELECTRICITY SUPPLY

Before connecting to the electricity supply please familiarise yourself with the parts of the handbook relevant to your model.

Your unit's supply voltage requirement is specified on a plate on the instrument along with the serial number. All Pegasus^{Plus} 1200 instruments will work on an electricity supply frequency of 50Hz or 60Hz.



The apparatus is provided with an approved power cord. If the plug is not suitable for your location then the plug should be removed and replaced with an appropriate plug.

Take care to ensure the old plug is disposed safely.

The cable is colour coded as follows:

<u>COLOUR</u>	<u>FUNCTION</u>
Green/yellow	Earth (Ground)
Brown	Live (line)
Blue	Neutral

Please ensure that your unit is correctly connected to the electricity supply.

A Residual Current Device sometimes called an RCD, ELCB or ground fault detector is included



with 230VAC Pegasus^{Plus} 1200 models.

It is fitted in line with the Pegasus^{Plus}.

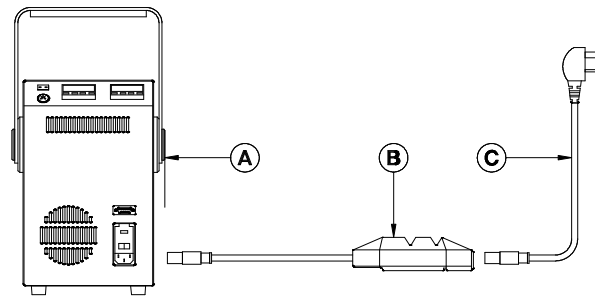

- (A) PEGASUS 1200**
- (B) RESIDUAL CURRENT DEVICE**
- (C) POWER CORD**

This RCD provides additional safety protection against fault conditions and must be used with 230VAC models.

THE APPARATUS MUST BE CORRECTLY EARTHED (GROUNDED)

The units on/off switch is located on the power inlet. Take care NOT to switch the unit off when it is hot - allow to cool first.

SPECIFICATION

Voltage	:	230VAC (<u>or</u> 115VAC) see ratings plate
Power	:	2.5kW
Supply Frequency	:	50/60Hz
Maximum Operating Temperature	:	1200°C
Minimum Operating Temperature	:	150°C
Stability	:	±0.05 to ±0.2°C
Calibration Volume	:	33.5mm φ by 130mm
Standard Insert Hole Dimensions:	:	4 x 8mm φ
Insert Options	:	Special drillings available to customer requirements.
Dimensions (not including handle)	:	Height 302mm Width 176mm Depth 262mm
Weight	:	8.50Kg

PEGASUS UNCERTAINTY

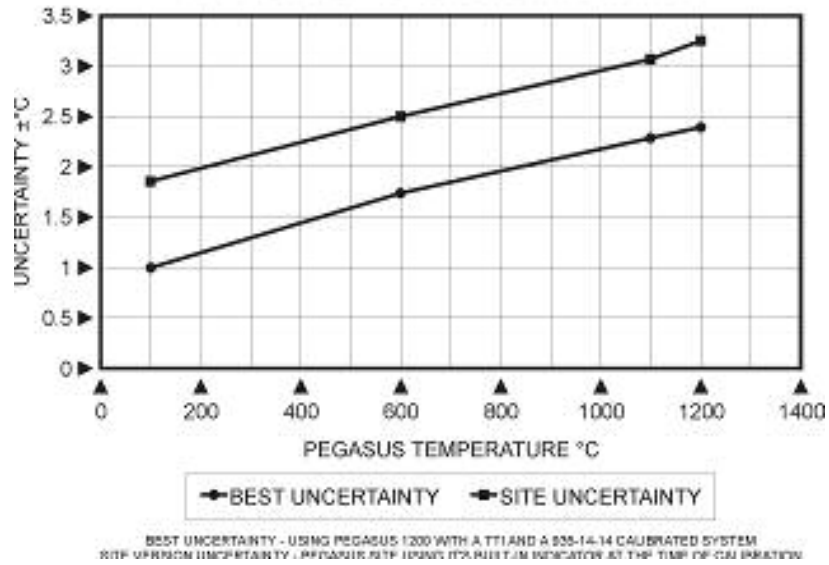

PEGASUS 1200 HEAT UP / COOL DOWN

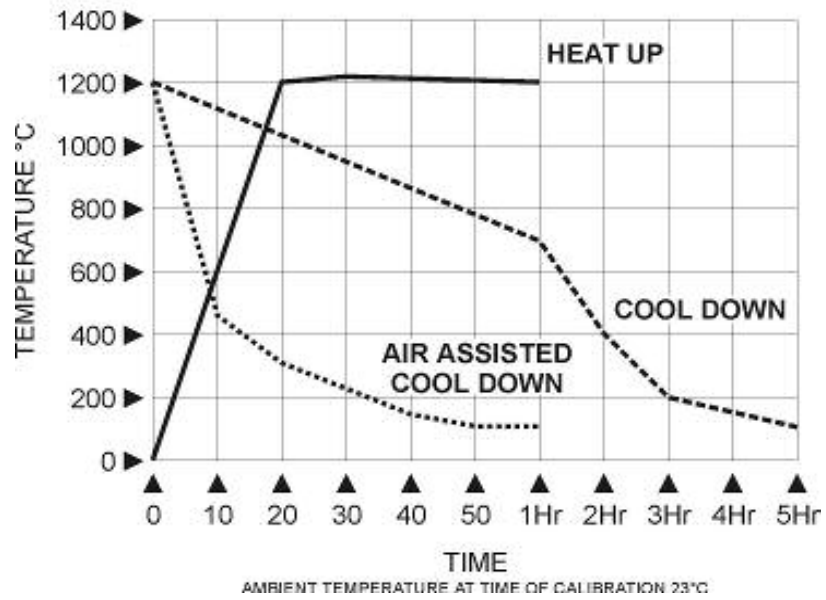

A full evaluation of the Pegasus 1200 is available contact the factory for availability

ASSEMBLING THE INSERT



The insert is connected to EARTH (Ground) by a metal spike, see diagram. It is essential this connection is made.

TO ASSEMBLE THE INSERT

1. Ensure furnace is cool.
2. Slide the long ceramic insulator down the furnace tube so that the tip of the spike protrudes. (This can be checked by using a ruler or similar).
3. Carefully lower the insert using the extractor tool.
4. Unscrew extractor tool.
5. Finally add the smaller top ceramic insulator.

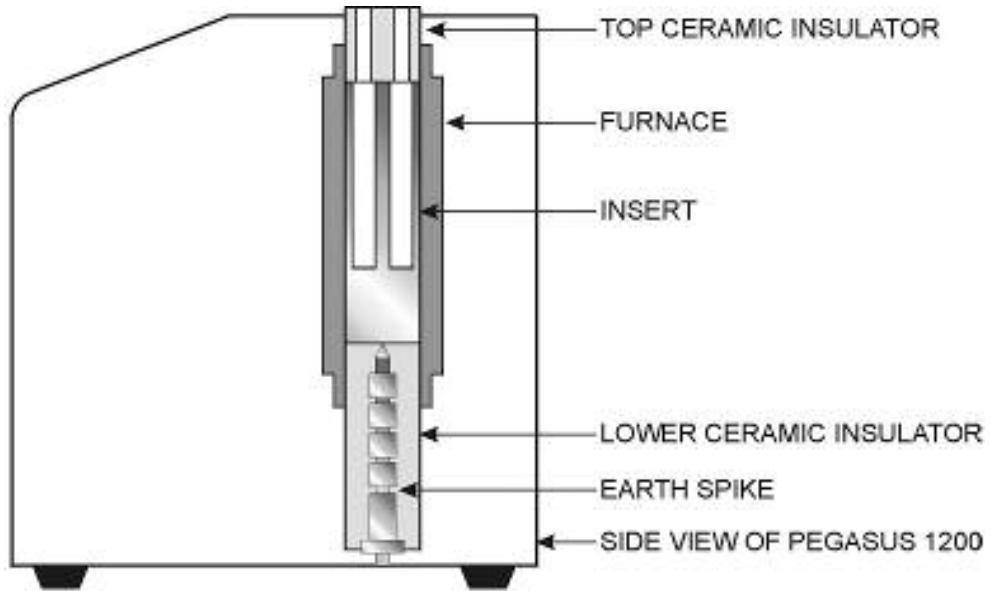

THE INSULATORS MUST BE USED AS SHOWN

OPERATING THE ^{Plus} MODEL

FRONT PANEL LAYOUT

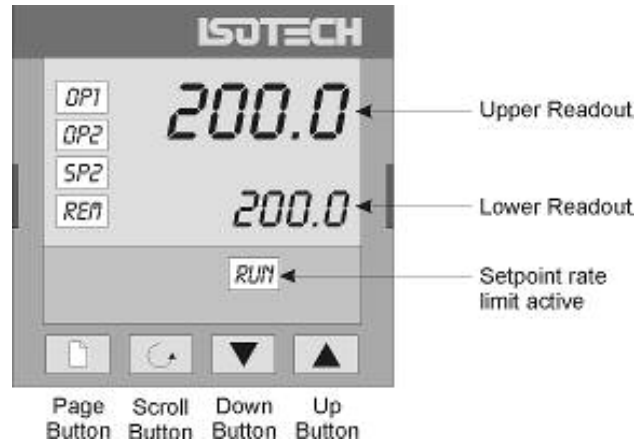

The Temperature Controller

The controller has a dual display, the upper display indicates the nominal block temperature, and the lower display indicates the desired temperature or setpoint.

Altering the Setpoint

To change the setpoint of the controller simply use the UP and DOWN keys to raise and lower the setpoint to the required value. The lower display changes to indicate the new setpoint.

Advanced Controller Features

Setpoint Ramp Rate

The Pegasus^{Plus} units incorporate an automatic setpoint ramp rate which limits the heat up rate to a safe value which will not stress the ceramic furnace assembly.

After the setpoint is change the controller will automatically move the setpoint from the current value to the target value at a preset rate.

The lower display will be seen to increment towards the target value.

The target (final) value may be inspected by momentarily pressing either the UP or DOWN key.

The setpoint ramp rate will also be seen when the unit is cooling although it does not increase the cooling time.

Instrument Address

The controller has a configurable "address" which is used for PC communications. Each instrument has an address, this allows several instruments to be connected in parallel on the same communications bus. The default value is 1. This address would only need to be changed if more than one Dry Block is connected to the same PC port.

To check the Address value press the scroll key until the top display indicates,

Addr

The lower display will show the current value that can be modified with the UP and DOWN keys.

Monitoring the Indicator Status

A row of beacons indicate the controllers status as follows,

OP1	Heat Output
OP2	Cool Output (Only for models which operate below 0°C)
REM	This beacon indicates activity on the PC interface

Units

Momentary pressing the Scroll key will show the controller units °C or °F.

The Temperature Indicator (Site (S) Models Only)

The site models include an electronic temperature indicator. The indicator can be configured for the desired sensor type, and for custom calibration data. The custom calibration data can be set ON or OFF.

Setting the Input Type

A 100 Ohm resistance thermometer can be connected to the PRT Connector or a thermocouple may be connected to the miniature TC Connector.

Ensure that only a PRT or a TC is connected at any one time. If a PRT and TC are connected simultaneously the indicator will read in error.



Check that any sensor placed into the Pegasus is suitable for the temperature range. Sensors can be damaged if taken outside their normal operating limits.

The desired sensor type is easily set, press the Scroll key until the upper display indicates,

inPt

On the upper display. The lower display will show the current set sensor type,

J.tc	J thermocouple
K.tc	K thermocouple
L.tc	L thermocouple
r.tc	R thermocouple (Pt/Pt13%Rh)
b.tc	B thermocouple (Pt30%Rh/Pt6%Rh)
n.tc	N thermocouple
t.tc	T thermocouple
S.tc	S thermocouple (Pt/Pt10%Rh)
PL.2	PL 2 thermocouple
rtd	100Ω platinum resistance thermometer.
T012	E thermocouple

Again the value can be modified with the UP and DOWN keys.

Enabling / Disabling Custom Calibration

Custom calibration allows the indicator to be programmed to suit a particular temperature sensor. This allows the indicator to automatically show the true temperature, without having to manually apply a correction.

When the Custom or User Calibration is active the indicator will show the REM beacon lit continuously. The use of User calibration can make a significant difference to the accuracy of the instrument, and this REM beacon provides a clear and continuous indication of the calibration status. Isotech will configure and set user calibration when the Dry Block is ordered with a temperature sensor.

To alter the calibration status press the Scroll key until the upper display shows,

CAL

The lower display will indicate either,

USER for user calibration

Or

FACT for factory calibration of the indicator, i.e. User Cal OFF

Use the UP and DOWN keys to toggle between the two values.

When calibrating an unknown sensor against a calibrated probe it may be necessary to switch the calibration off for the unknown, and on for the calibrated probe.

Instrument Address

Like the controller, the indicator has a configurable "address" which is used for PC communications. Each instrument has an address; this allows several instruments to be connected in parallel on the same communications bus. The default value is 2 (The controller defaults to 1). This address would only need to be changed if more than one Dry Block is connected to the same PC port.

To check the Address value press the scroll key until the top display indicates,

Addr

The lower display will show the current value that can be modified with the UP and DOWN keys.

Monitoring the Controller Status

For the indicator the REM beacon is lit continuously when the user calibration is active, the REM beacon flashes when the PC communications port is active.

Units

Momentary pressing the Scroll key will indicate the controller units (°C or °F).

Advanced Indicator Operation

The indicator can be configured with up to five custom calibration points; the points contain "data pairs". First the temperature (point) and secondly the Error (offset) at this temperature point. Isotech Dry Block calibration certificates will show the values to suit a particular sensor.

These values can be inspected, and modified with the following procedure,

Press the PAGE key until the display indicates,

ACCS
LiSt

Press the SCROLL key until the display shows,

Goto
OPeR

Press the UP key until the display shows

Goto
conF

Press the Scroll Key twice, when the display will show,

inSt
 Conf

Press the Page Key until the controller shows

CAL
 Conf

Now use the Scroll key to examine the data pairs. The values can be modified with the UP and DOWN keys.

To exit this mode press the Page key until the top display shows,

Exit

And then set the lower display to YES. While in this mode take care not to modify other parameters - a full list of all the parameters can be found in appendix 3.

CALIBRATION DATA EXAMPLE

A maximum of five points may be entered, shown as Pnt 1 to Pnt 5 for the temperature point and Ofs 1 to Of 5 for the offset values.

The Pnt values must be entered in ascending order.

Set a Pnt to a value lower than the previous point to disable it.

The indicator would be programmed with the following data:

Pnt 1	100	Ofs 1	0.8
Pnt 2	300	Ofs 2	1.1
Pnt 3	500	Ofs 3	2.1
Pnt 4	-999	Ofs 4	0
Pnt 5	-999	Ofs 5	0

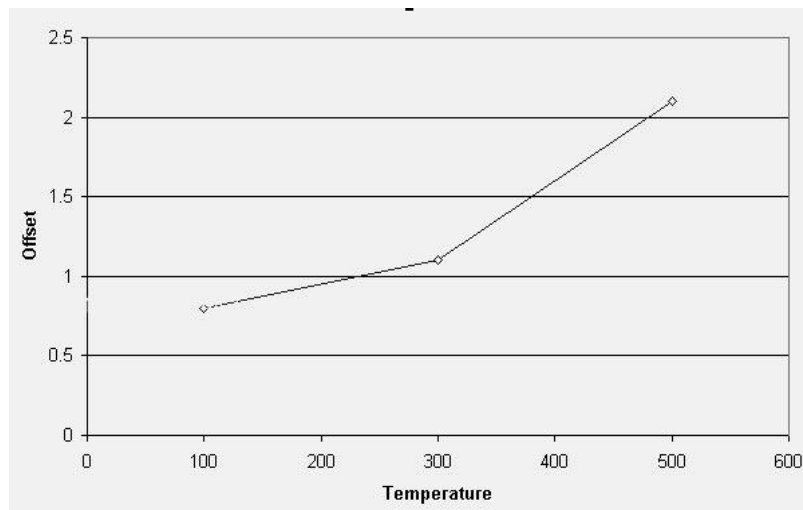

CONNECTING A CURRENT TRANSMITTER (UP TO 20MA)

The transmitter should be powered externally, a 2.49Ω current sense resistor is fitted internally and this allows the indicator to read mA.

1. From the input type menu select “mV”.
2. Access configuration level.

SELECTING CONFIGURATION LEVEL

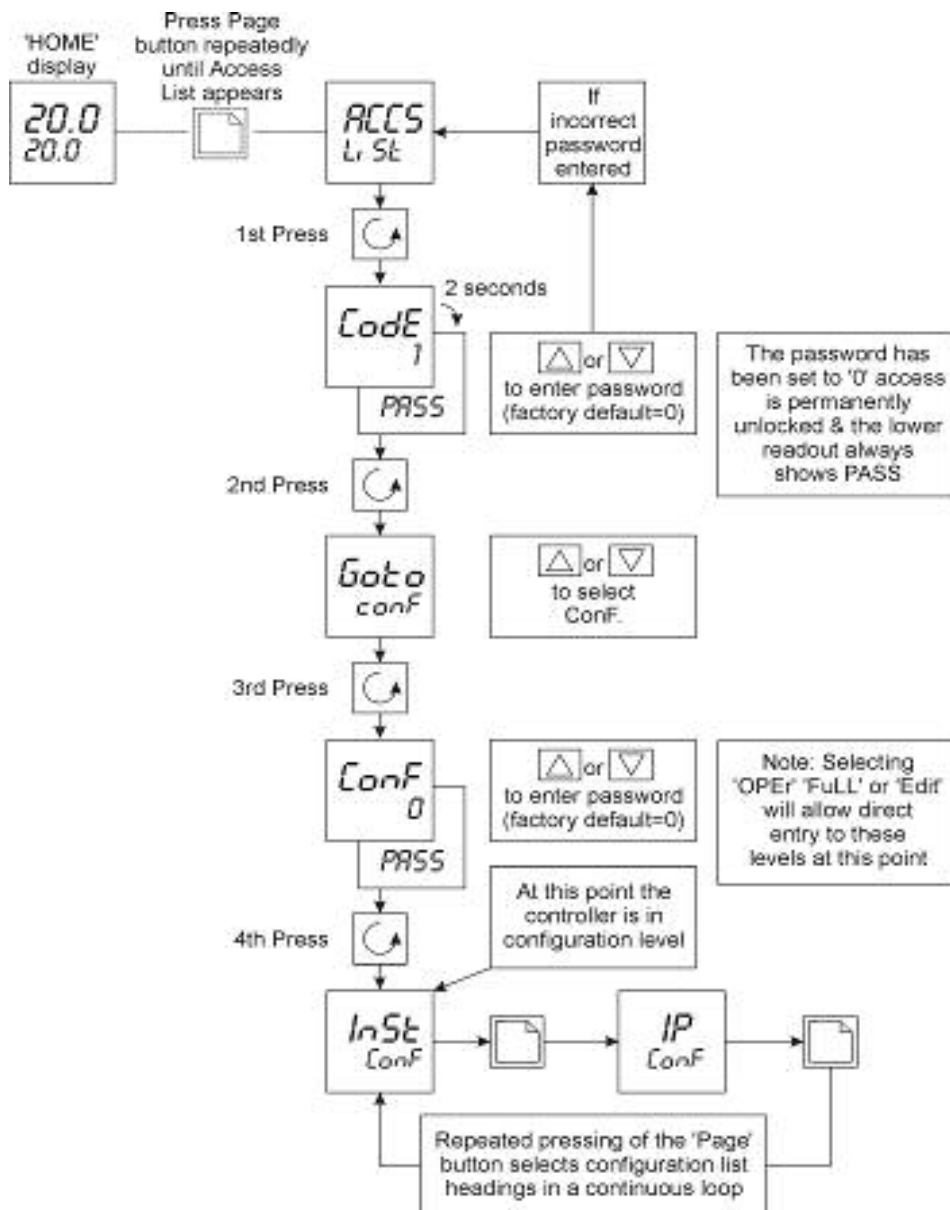

From the input menu iP set the inP.L, inP.H, VAL.L and VAL.H parameters to suit see table below;

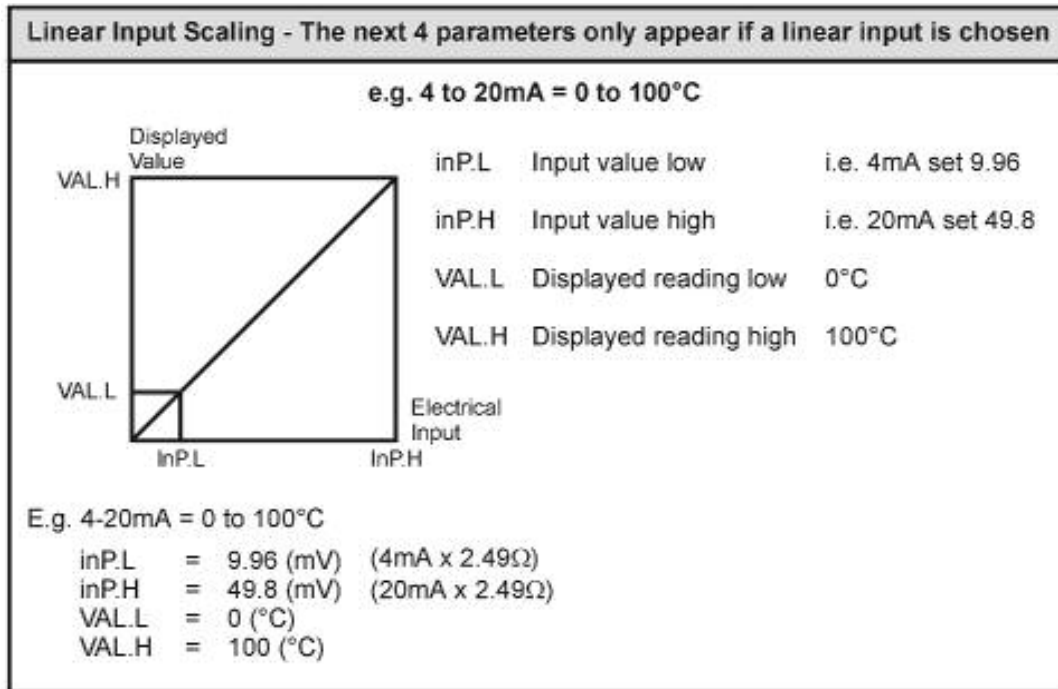

Exit config level by pressing PAGE key until the top display shows Exit, use the UP key to select YES, after two seconds the instrument will reset.

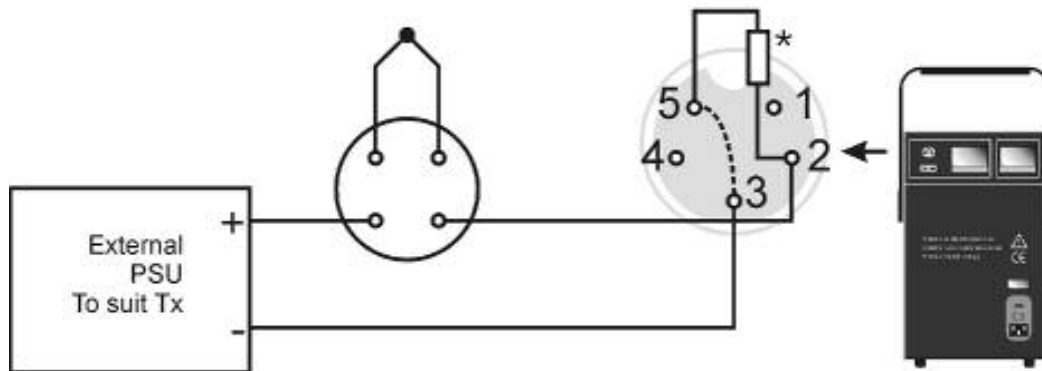

*2.49Ω resistor fitted internally (Pins 2 and 5).

Link Pins 3 and 5 for transmitter inputs.

Remove link for T/C's and PRT's.

Socket Pins shown from Panel View

Using the PC Interface

The Plus models include an RS422 PC interface, a special converter cable that allows use with the a standard RS232 port. When using the bath with an RS232 port it is essential that this converter cable is used. Replacement cables are available from Isotech, part number ISO-232-432. A further lead is available as an option, Part Number ISO-422-422 lead which permits up to 5 instruments to be daisy chained together.

The benefit of this approach is that a number of calibration baths may be connected together in a "daisy chain" configuration - and then linked to a single RS232, see diagram.



Note: The RS 422 standard specifies a maximum lead length of 1200M (4000ft). A true RS422 port will be required to realise such lead lengths. The Isotech conversion leads are suitable for maximum combined lead lengths of 10M that is adequate for most applications.

Connections

For RS232 use simply connect the Isotech cable, a 9 to 25 pin converter is included to suit PCs with a 25 pin serial converter.

RS422 Connections

Pin	Connection
4	Tx+ A
5	Tx- B
8	Rx+ A
9	Rx- B
1	Common

Using the Interface

The models are supplied with Cal NotePad as standard. This easy to use package is compatible with MS Windows 9x. A handbook for Cal NotePad can be found on the first installation disk in Adobe PDF format. If required a free Adobe PDF reader can be downloaded from, www.adobe.com.

CAL NOTEPAD

Cal Notepad can be used to log and display values from the Dry Blocks and an optional temperature indicator.

Minimum System Requirements

CNP requires Windows 95 / 98, a minimum of 5Mb of free hard drive space and free serial ports for the instruments to be connected.

Development

CNP was developed by Isothermal Technology using LabVIEW from National Instruments.

License

Use of the Cal NotePad software program "CNP" is as granted in this license agreement. In using the CNP software the user "licensee" is agreeing to the terms of the license. You must read and understand the terms of this license before using CNP.

- 1, This license permits licensee to use CNP software on a single computer. The user may make copies for back up and archival purposes freely as long as the software is only ever in use on a single computer at any one time. Please enquire about multi-user licenses.
- 2, CNP is protected by international copyright laws and treaties. CNP must not be distributed to third parties.
- 3, CNP must not be reversed engineered, disassembled or de-compiled. Licensee may transfer the software to a third party provided that no copies or upgrades of CNP are retained.
- 4, It is the responsibility of the user to ensure the validity of all stored results and printed certificates. Isothermal Technology Ltd accept no responsibility for any errors caused by inappropriate use, incorrect set up or any other cause; including defects in the software.
- 5, Limited Warranty. Isothermal Technology warrants that CNP will perform substantially as described in this manual for a period of 90 days from receipt. Any distribution media will under normal used be guaranteed for a period of 90 days.

NO OTHER WARRANTIES, EXCEPT AS STATED ABOVE. The software and documentation is provided "as is" without warranty of any kind and no other warranties (either expressed or implied) are made with regard to CNP. Isothermal Technology does not warrant, guarantee or make any representations regarding the use or results of the use of the software or documentation and does not warrant that the operation of CNP will be error free.

In no event will Isothermal Technology, its employees, agents or other associated people be liable for direct, indirect, incidental or consequential damages, expenses, lost profits, business interruption, lost business information or other damages arising out the use or inability to use CNP. The license fee reflects this allocation of risk.

CNP is not designed for situations where the results can threaten or cause injury to humans.

Installing Cal NotePad

3. Insert CNP DISK 1 into the disk drive
4. Click on the START button on the task bar, select RUN, type A:\SETUP (Where A: is your drive letter) then click OK
5. Follow the prompts which will install the application and necessary LabVIEW run time support files.
4. Should you ever need to uninstall the software then use the Add/Remove Programs option from the Control Panel.

Starting Cal NotePad

From a Standard Installation:

Click the START button

Highlight PROGRAMS

Select Isotech - Select Calpad

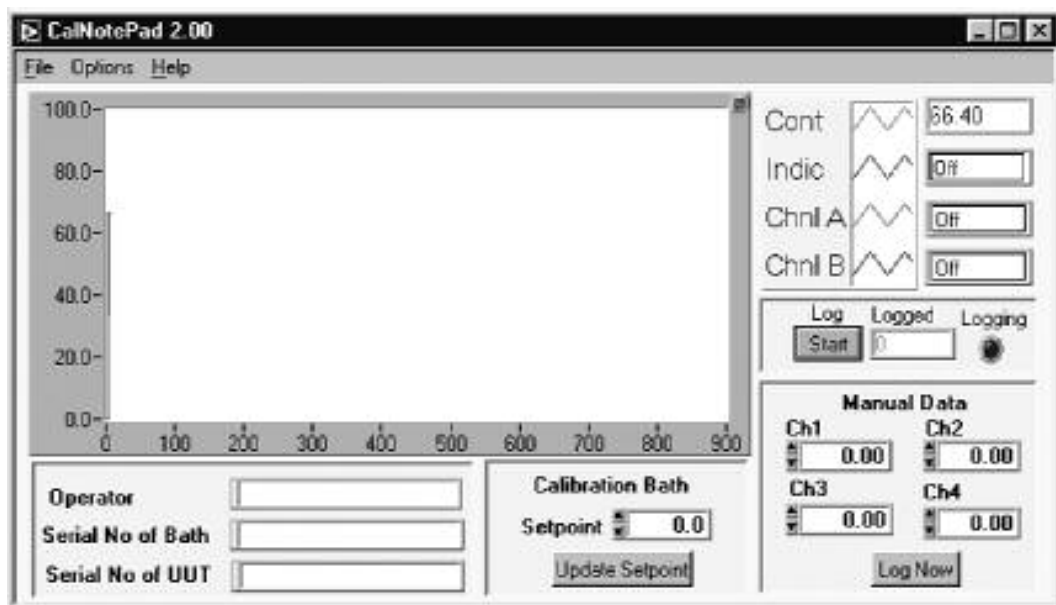

Protocol

The instruments use the "Eurotherm EI BiSynch Protocol"

If required, e.g. for writing custom software the technical details are available from our website at, www.isotech.co.uk/refer.html

Diagnostic alarms

These indicate that a fault exists in either the controller, indicator or the connected sensor.

Controller Error Messages

The instruments include powerful diagnostics and in the unlikely event of an internal failure, or a sensor error, one of the following error messages may be displayed.

Display shows	What it means	What to do about it
EE.Er	<i>Electrically Erasable Memory Error:</i> The value of an operator or configuration parameter has been corrupted	For Controller: Contact Isotech For Indicator: Check Config Against Data in Appendix
S.br	<i>Sensor Break:</i> Input sensor is unreliable or the input signal is out of range.	For Controller: Contact Isotech For Indicator: Check a sensor is connected. Check that only a PRT or a TC is Connected (Not both)
HW.Er	<i>Hardware error :</i> Indication that a module is of the wrong type, missing or faulty	Contact Isotech
LLLL	<i>Out of Display range, low reading</i>	For Controller: Contact Isotech For Indicator: Check Sensor and Connections
HHHH	<i>Out of Display range, high reading</i>	For Controller: Contact Isotech For Indicator: Check Sensor and Connections
Err1	<i>Error 1: ROM self-test fail</i>	Consult Isotech
Err2	<i>Error 2: RAM self-test fail</i>	Consult Isotech
Err3	<i>Error 3: Watchdog fail</i>	Consult Isotech
Err4	Error 4: Keyboard failure Stuck button, or a button was pressed during power up.	Switch the power off and then on without touching any of the controller buttons.
Err5	<i>Error 5: Input circuit failure</i>	Consult Isotech
Pwr.F	<i>Power failure.</i> The line voltage is too low	Check that the supply to the controller is within the rated limits

PEGASUS^{Plus} 1200B, 1200S

INITIAL TESTING

This unit was fully tested before despatch to you but please check its operation as outlined below.

After connecting the Pegasus^{Plus} 1200 to the electricity supply, the temperature controller display will show the temperature of the block and the last set-point value. The S controller and indicator both go through a self-test sequence first. The fan on the front panel should be heard running. Assemble the insert as shown on pages 13 and 14.

Change the set-point to 300°C and observe that the block temperature rises and settles to this value. For the S; place a thermometer in an insert in the block and connect it to the suitably configured indicator. Confirm that the indicator agrees within $\pm 2^{\circ}\text{C}$ of the controller.

Your unit should have performed as described above and can now be used for calibration.

If any problems or faults arise during these tests please contact us or our agents for help and advice.



To prolong heater life we recommend that the temperature should not be increased by increments greater than 500°C.



IMPORTANT NOTICE

The controller's function settings are preset and will not require adjustment.

FAST COOL DOWN PROBE (OPTION)

The fast cool down probe can be attached to a suitable air supply and then placed into the Pegasus insert for rapid cooling.



Take care when placing the probe into the hot block.

Ensure the air supply is set to give an appropriate flow rate. Guard against setting so high that the probe may be blown from the insert.

PEGASUS^{Plus} 1200B, 1200S

MAINTENANCE

Turn the electricity supply off before attempting any cleaning operation.

The only moving part is the fan. It has sealed-for-life bearings. Depending on the environment in which it is used, periodic cleaning of the fan and the inside of the case is recommended. Cleaning may be accomplished by the use of a small dry paint brush.

The instrument should be periodically checked to ensure it is in good order both mechanically and electrically.

THE BASIC WORKINGS OF THE PEGASUS^{Plus} 1200

The purpose of the Pegasus^{Plus} 1200 models is to provide an adjustable isothermal enclosure for calibration purposes.

The isothermal enclosure consists of a small furnace into which an insert can be placed. Items for calibration are placed in suitably drilled holes in the insert. The replaceable inserts enable a variety of items to be calibrated.

The furnace consists of a specially wound tube assembly. A control sensor is used by the temperature controller to sense the furnace temperature. To obtain and maintain a required temperature the controller varies the power to the heaters via a solid state relay.

An internal fan runs continuously and cools the electronics in the instrument.

OPERATING PROCEDURES

The following operating procedures have been written for one of the two models as indicated by the Procedures heading.

Please note:-

No oils, greases or powders should be introduced into the Pegasus^{Plus} 1200 or its inserts.

PEGASUS^{Plus} 1200B, 1200S

CHECKING USING THE TEMPERATURE INDICATED ON THE CONTROLLER

1. Remove the Pegasus^{Plus} 1200 from its case and visually inspect it for any damage it may have sustained since it was last used. Insert the required metal insert into the furnace block using the tool supplied to avoid damage to the heater assembly.
2. Connect the Pegasus^{Plus} 1200 to a suitable power supply and set the controller to the required temperature.
3. Place the thermometer for calibration into a suitable hole in the metal insert and wait for the temperature to stabilise.
4. When the temperature indicated by the controller and the output of the thermometer are both stable (see specification for typical values) record three sets of readings over a period of about six minutes. Check that these readings are consistent and then calculate their average values.
5. If the Pegasus^{Plus} 1200 has itself been calibrated, correct the average values accordingly.
6. Reset the controller and/or repeat the calibration for another thermometer.
7. When the calibration is complete, reset the controller to 0°C and wait until the unit has cooled to below 600°C before moving the Pegasus^{Plus} 1200 to a new location. The Pegasus^{Plus} 1200 must be cooled below 100°C before it can be put back into its carrying case.

PEGASUS^{Plus} 1200B, 1200S

CALIBRATION USING A STANDARD THERMOMETER WITH EXTERNAL INDICATION.

1. Remove the Pegasus^{Plus} 1200 from its case and visually inspect it for any damage it may have sustained since it was last used. Insert the required metal insert into the furnace block using the tool supplied to avoid damage to the heater assembly.
2. Connect the Pegasus^{Plus} 1200 to a suitable power supply and set the controller to the required temperature.
3. Place the thermometer(s) for calibration and the standard thermometer into suitable holes in the metal insert; wait for the temperature to stabilise.
4. When the temperature indicated by the controller and that of the other thermometers are stable (see specification for typical values) record three sets of readings over a period of about six minutes. Check that these readings are consistent and use their average values for the final calibration figures.

Compare the units under test to the standard thermometer.

5. Reset the controller and/or repeat the calibration for another thermometer.
6. When the calibration is complete, reset the controller to 0°C and wait until the unit has cooled to below 600°C before moving the Pegasus^{Plus} 1200 to a new location. The Pegasus^{Plus} 1200 must be cooled below 100°C before it can be put back into its carrying case.

PEGASUS^{Plus} 1200S

CALIBRATION USING A STANDARD THERMOMETER AND THE INTERNAL INDICATOR

1. Remove the Pegasus^{Plus} 1200 from its case and visually inspect it for any damage it may have sustained since it was last used. Insert the required metal insert into the furnace block using the tool supplied to avoid damage to the heater assembly.
2. Connect the Pegasus^{Plus} 1200 to a suitable power supply and set the controller to the required temperature.
3. Place the thermometer(s) for calibration into a suitable insert(s) in the metal block and wait for the temperature to stabilise, connect the standard thermometer to the indicator.

Ensure the indicator is configured for the correct sensor and where applicable the calibration data has been entered and user calibration enable - see pages 16 to 19.

4. When the temperature indicated by the controller and that of the other thermometers are stable (see specification for typical values) record three sets of readings over a period of about six minutes. Check that these readings are consistent and use their average values for the final calibration figures.
5. Compare the units under test to the value from the in-built indicator.
6. If the Pegasus^{Plus} 1200 has been calibrated, correct the figures accordingly.
7. Reset the controller and/or repeat the calibration for another thermometer.
8. When the calibration is complete, reset the controller to 0°C and wait until the unit has cooled to below 600°C before moving the Pegasus^{Plus} 1200 to a new location. The Pegasus^{Plus} 1200 must be cooled to below 100°C before it can be put back into its carrying case.

PEGASUS^{Plus} 1200S

**CALIBRATION USING THE INTERNAL INDICATOR TO READ A STANDARD
AND UNKNOWN THERMOMETERS**

1. Remove the Pegasus^{Plus} 1200 from its case and visually inspect it for any damage it may have sustained since it was last used. Insert the required metal insert into the furnace block using the tool supplied to avoid damage to the heater assembly.
2. Connect the Pegasus^{Plus} 1200 to a suitable power supply and set the controller to the required temperature.
3. Place the thermometer(s) for calibration and the standard thermometer into suitable holes in the metal insert; wait for the temperature to stabilise.
4. When the temperature indicated by the controller and the standard are stable (see specification for typical values) record the reading of the standard. Connect the thermometer under test, in place of the standard, to the indicator and re-configure the indicator for the new sensor type as necessary. If user calibration is enable for the standard it will need to be turned off or modified for the unit under test - see pages 16 to 19. Record the temperature of the thermometer under test. For security reconnect the standard thermometer, reconfigure the indicator and make sure the temperature has not changed from the first reading.
5. If the Pegasus^{Plus} 1200 has itself been calibrated, correct the average values accordingly.
6. Reset the controller and/or repeat the calibration for another thermometer.
7. When the calibration is complete, reset the controller to 0°C and wait until the unit has cooled to below 600°C before moving the Pegasus^{Plus} 1200 to a new location. The Pegasus^{Plus} 1200 must be cooled to below 100°C before it can be put back into its carrying case.

PEGASUS^{Plus} 1200S

USING THE INDICATOR TO MEASURE TEMPERATURES REMOTE FROM THE FURNACE

1. Remove the Pegasus^{Plus} 1200 from its case and visually inspect it for any damage it may have sustained since it was last used. Insert the required metal insert into the furnace block using the tool supplied to avoid damage to the heater assembly.
2. Connect the Pegasus^{Plus} 1200 to a suitable power supply and set the controller to either 0°C if the furnace is not to be used or to the required temperature if it is going to be used to calibrate thermometers.
3. If the standard thermometer is going to be used to measure a temperature other than the metal block, reconfigure and set the user calibration of the indicator accordingly. Connect the standard thermometer to the indicator which will now display its temperature.
4. If the indicator is going to be used to measure the temperature of a remote thermometer, reconfigure and set the user calibration of the indicator to correspond to that type of thermometer, connect the thermometer to the indicator and the corresponding temperature will be displayed. See pages 16 to 19 details of user calibration.
5. If the Pegasus^{Plus} 1200 has itself been calibrated, correct the average values accordingly.
6. Reset the controller and/or repeat the calibration for another thermometer.
7. When the calibration is complete, reset the controller to 0°C and wait until the unit has cooled to below 600°C before moving the Pegasus^{Plus} 1200 to a new location. The Pegasus^{Plus} 1200 must be cooled to below 100°C before it can be put back into its carrying case.

FIGURE 1

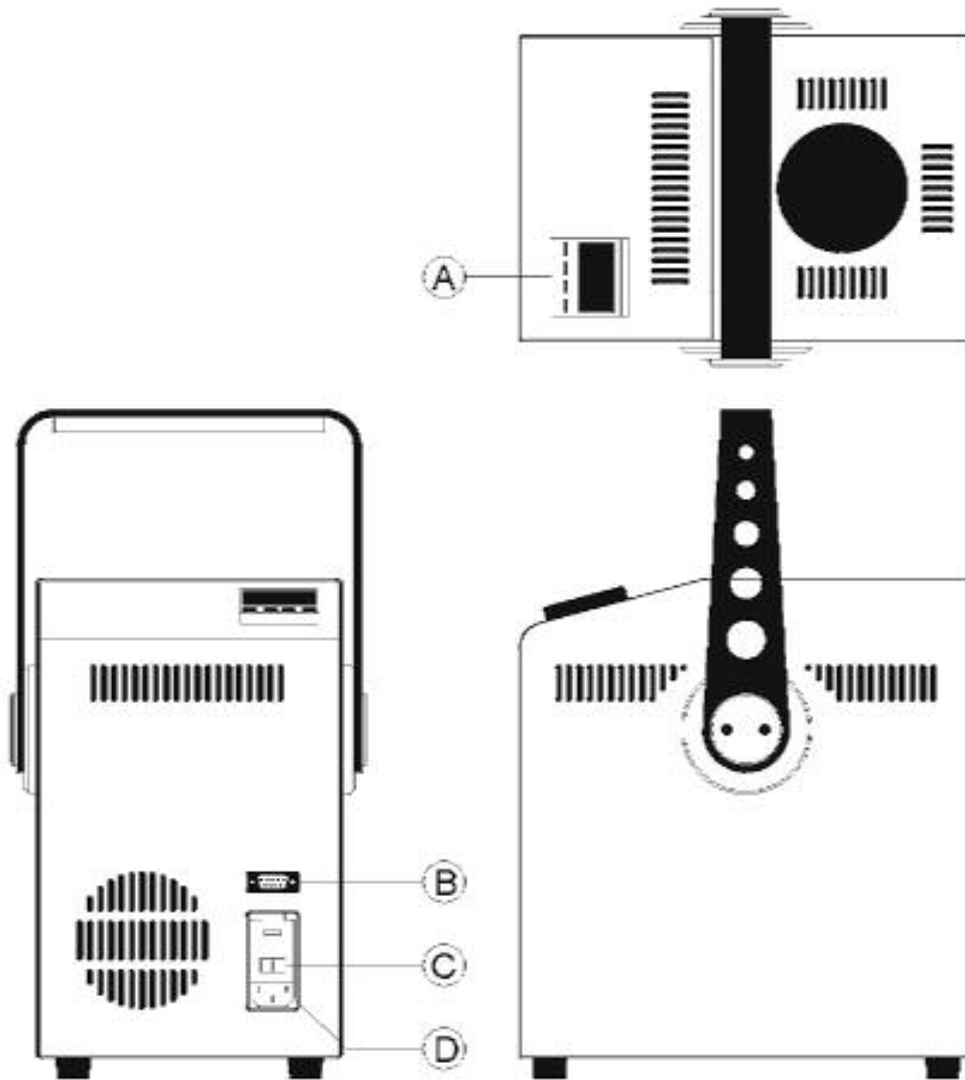

- (A) Temperature Controller
- (B) PC Interface
- (C) On/Off Switch
- (D) Power Entry and Fuse

FIGURE 2

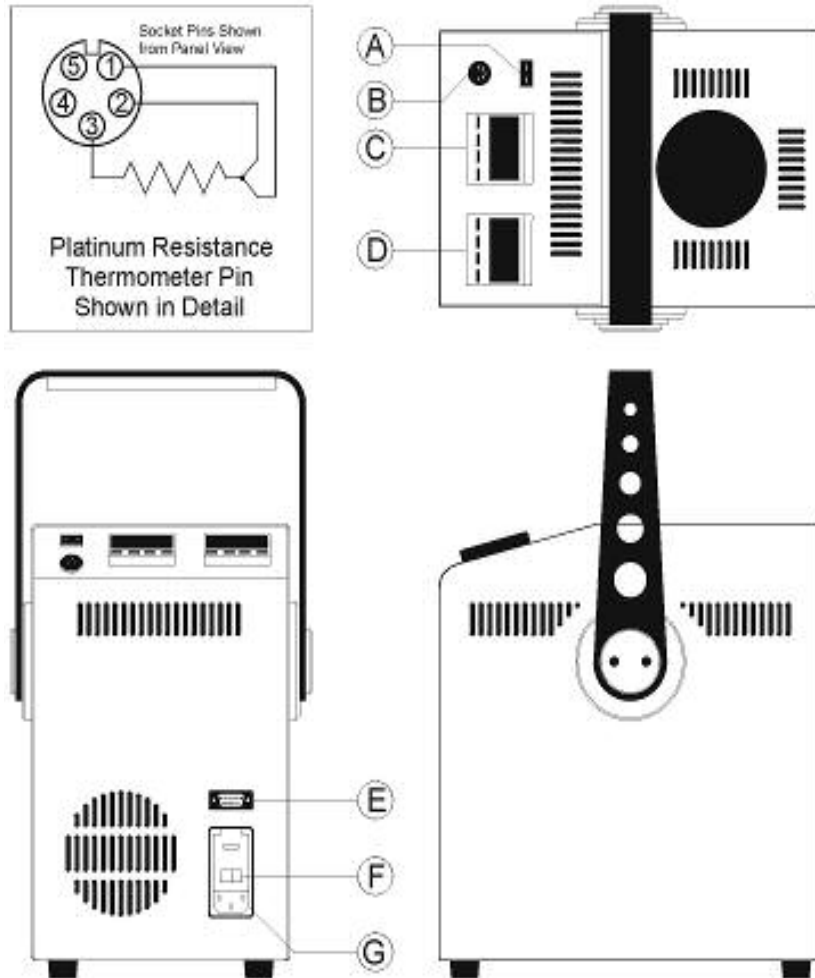

- (A) Thermocouple Connector
- (B) Platinum Resistance Thermometer Connector
- (C) Temperature Indicator
- (D) Temperature Controller
- (E) Communications Connector (optional)
- (F) On/Off Switch
- (G) Power Entry and Fuse

NOTE: Only connect a thermocouple or platinum resistance thermometer to the input connectors. Ensure that only one sensor is connected at any one time.

APPENDIX 1

PEGASUS^{Plus} 1200

TROUBLE SHOOTING

1. Large Temperature Difference

Ensure the top and bottom ceramic insulators are in place - see pages 13 and 14.
Ensure that all thermocouples are at the same depth.

2. Controller Lower Display Constantly Changes after setpoint change

This is normal procedure - refer to page 15

3. Cannot establish PC Communications

For RS232 you must use the Isotech adaptor cable.
Ensure the addresses of the controller and indicator match those set in Cal Notepad.
Ensure each controller and indicator are set to a unique address.
Refer to 'Using the PC Interface' section and the Cal Notepad manual for further details.

APPENDIX 2

ACCESSORIES PARTS LIST

Type R Thermocouple	935-14-14
Undrilled Insert	853-02-02B
Standard Insert	853-02-02A
Special Insert	Consult Factory
Fuse 230VAC Models	20mm 10amp quick blow RS Components 416-405
PRT Plug	935-16-75
T/C Plug (Type R)	935-35-101
Fast Cool Down Probe	853-04-02
Ceramic Insulation Pack	853-06-04

APPENDIX 3

INDICATOR CONFIGURATION (Reference Only)

Config.INST

Name	Description	Value
unit	Instrument Units	°C (0)
dEcP	Decimal Places in Display	NNN.N (1)
Ctrl	Control Type	PID (0)
Act	Control Action	REV (0)
COOL	Cooling Type	LIN (0)
PwrF	Power Feedback Enable	OFF (0)
Pdtr	Manual/Auto Transfer PD Control	NO (0)
FoP	Forced Output Enable	NO (0)
Sbrt	Sensor Break Type	SB.OP (0)
rnGH	Process Value High Limit	1220.00
rnGL	Process Value Low Limit	0.00

Config.IP

Name	Description	Value
inPt	Linearisation Type	R.TC (3)
CJC	CJC Type	(EXT)
imP	Sensor break impedance	AUTO (1)

Config.CAL

Name	Description	Value
UCAL	User Calibration Enable	YES (1)
Pnt1	User Cal Point 1	0
Pnt5	User Cal Point 5	-99.00
OFS1	User Cal Offset 1	0.00
Pnt2	User Cal Point 2	-99
OFS2	User Cal Offset 2	0.00
Pnt3	User Cal Point 3	-99
OFS3	User Cal Offset 3	0.00
Pnt4	User Cal Point 4	-99.00
OFS4	User Cal Offset 4	0.00
OFS5	User Cal Offset 5	0.00

Note: User Cal values are unique to each instrument. If available set values to those from calibration certificate

Config.AL

Name	Description	Value
AL_1	Alarm 1 Type	OFF (0)
Ltch1	Alarm 1 Latching	NO (0)
AL_2	Alarm 2 Type	OFF (0)
Ltch2	Alarm 2 Latching	NO (0)
AL_3	Alarm 3 Type	OFF (0)
Ltch3	Alarm 3 Latching	NO (0)
AL_4	Alarm 4 Type	OFF (0)
Ltch4	Alarm 4 Latching	NO (0)

Config.HA

Name	Description	Value
id	Module Identity	CMS (7)
Func	Module Function	CMS (65)
bAud	Baud Rate	9600 (0)
Prty	Comms Parity	NONE (0)
rES	Comms Resolution	FUL (0)

Config.1A

Name	Description	Value
id	Module Identity	LOG (3)
Func	Module function	NONE (0)
SEnS	Sense of Output	NOR (0)

Config.2A

Name	Description	Value
id	Module Identity	LOG (3)
Func	Module function	NONE (0)
SEnS	Sense of Output	NOR (0)