

**ISOCAL-6
VENUS^{PLUS} 2140**



Isotech North America
158 Brentwood Drive, Unit 4
Colchester, VT 05446

Phone: (802)-863-8050
Fax: (802)-863-8125

www.isotechna.com
sales@isotechna.com

The company is always willing to give technical advice and assistance where appropriate. Equally, because of the programme of continual development and improvement we reserve the right to amend or alter characteristics and design without prior notice. This publication is for information only.

CONTENTS



<u>PAGE</u>	<u>DESCRIPTION</u>
3,4	EMC Information
5	Health & Safety Instructions
6	Do's and Don'ts
7	Guarantee
8	Cautionary Note
9	Unpacking & Initial Inspection
10,11,12	Introduction
13,14	Mode of Operation
15	How to measure the true temperature inside the accessories supplied with the Isocal-6
16	Specification
17	Performance Graphs
18	Operating the Controller
19,20,21,22,23	Operating the Indicator
24,25	Connecting a Current Transmitter (up to 20mA)
26	Using the PC Interface
27,28	Using Cal Notepad
29	Diagnostics
30	Initial Testing
31	Maintenance
32	Figure 1
33	Figure 2
34	Appendix 1 - Trouble Shooting
35,36	Appendix 2 - Indicator Configuration
37,38	Appendix 3 - Accessories



EMC INFORMATION

This product meets the requirements of the European Directive on Electromagnetic Compatibility (EMC) 89/336/EEC as amended by EC Directive 92/31/EEC and the European Low Voltage Directive 73/25/EEC, amended by 93/68/EEC. To ensure emission compliance please ensure that any serial communications connecting leads are fully screened.

The product meets the susceptibility requirements of EN 50082-1, criterion B.

Symbol Identification	Publication	Description
	ISO3864	Caution (Refer to Handbook)
	IEC 417	Caution, Hot Surface



ELECTRICAL SAFETY

This equipment must be correctly earthed.

This equipment is a Class 1 Appliance. A protective earth is used to ensure the conductive parts can not become live in the event of a failure of the insulation.

The protective conductor of the flexible mains cable which is coloured green/yellow **MUST** be connected to a suitable earth.

The blue conductor should be connected to Neutral and the Brown conductor to Live (Line).

Warning: Internal mains voltage hazard. Do not remove the panels.

There are no user serviceable parts inside. Contact your nearest Isotech agent for repair.

Voltage transients on the supply must not exceed 2.5kV.

Conductive pollution, eg. Carbon dust, must be excluded from the apparatus. EN61010 pollution degree 2.

The apparatus has two input connectors for temperature sensors, see Figure 1. These inputs are only suitable for either a thermocouple or resistance thermometer. No other sensor or signal may be connected.

ENVIRONMENTAL RATINGS

Operating Temperature 0-50°C

Relative Humidity 5-95%, non condensing



HEALTH AND SAFETY INSTRUCTIONS

1. Read all of this handbook before use.
2. Wear appropriate protective clothing.
3. Operators of this equipment should be adequately trained in the handling of hot and cold items and liquids.
4. Do not use the apparatus for jobs other than those for which it was designed, ie. the calibration of thermometers.
5. Do not handle the apparatus when it has hot (or cold), unless wearing the appropriate protective clothing and having the necessary training.
6. Do not drill, modify or otherwise change the shape of the apparatus.
7. Do not dismantle the apparatus.
8. Do not use the apparatus outside its recommended temperature range.
9. If cased, do not return the apparatus to its carrying case until the unit has cooled.
10. There are no user serviceable parts inside. Contact your nearest Isotech agent for repair.
11. Ensure materials, especially flammable materials are kept away from hot parts of the apparatus, to prevent fire risk.
12. Ensure adequate ventilation when using oils at high temperatures.

ISOCAL-6

'DO'S AND DON'TS'

DO NOT handle the accessories when they are very hot or very cold.

DO NOT place hot or cold accessories back in the carrying case

DO NOT use the pocket designed for the black body source sensor to measure the temperature of the insert, stirred liquid bath or surface calibrator.

DO use that pocket for pre-warming, pre-cooling or storage.

DO NOT spill liquids inside the Isocal-6

DO NOT use liquids outside their recommended temperature range

DO NOT use viscous liquids in the stirred liquid accessory, the stirring will be restricted and larger gradients will occur.

DO NOT mix liquids. If you are using 1 container for different liquids make sure the container is completely clean and dry before adding another liquid.

DO NOT worry if the black anodising gets discoloured or scratched. We can supply some special black touch up paint.

DO NOT rely on the controller to tell you the temperature of the insert or stirred liquid bath. It's job is only to provide an isothermal volume. It is the calibrated working standard that is used to measure actual temperature.

DO NOT calibrate very large sensors in the Isocal-6 unless you can accept large immersion errors. We have larger products for larger sensors.

DO NOT try to straighten the working standard, it is deliberately bent so that it does not interfere with the sensors you are calibrating.

GUARANTEE

This instrument has been manufactured to exacting standards and is guaranteed for twelve months against electrical break-down or mechanical failure caused through defective material or workmanship, provided the failure is not the result of misuse. In the event of failure covered by this guarantee, the instrument must be returned, carriage paid, to the supplier for examination and will be replaced or repaired at our option.

**FRAGILE CERAMIC AND/OR GLASS PARTS ARE NOT COVERED BY THIS
GUARANTEE**

**INTERFERENCE WITH, OR FAILURE TO PROPERLY MAINTAIN THIS INSTRUMENT
MAY INVALIDATE THIS GUARANTEE**

RECOMMENDATION

The life of your **ISOTECH** Instrument will be prolonged if regular maintenance and cleaning to remove general dust and debris is carried out.

We recommend this instrument to be re-calibrated annually.

Serial No:.....

Date:.....



Isotech North America
158 Brentwood Drive, Unit 4
Colchester, VT 05446

Phone: (802)-863-8050
Fax: (802)-863-8125

www.isotechna.com
sales@isotechna.com

The company is always willing to give technical advice and assistance where appropriate. Equally, because of the programme of continual development and improvement we reserve the right to amend or alter characteristics and design without prior notice. This publication is for information only.



CAUTIONARY NOTE

ISOTECH PRODUCTS ARE INTENDED FOR USE BY TECHNICALLY TRAINED AND COMPETENT PERSONNEL FAMILIAR WITH GOOD MEASUREMENT PRACTICES.

IT IS EXPECTED THAT PERSONNEL USING THIS EQUIPMENT WILL BE COMPETENT WITH THE MANAGEMENT OF APPARATUS WHICH MAY BE POWERED OR UNDER EXTREMES OF TEMPERATURE, AND ARE ABLE TO APPRECIATE THE HAZARDS WHICH MAY BE ASSOCIATED WITH, AND THE PRECAUTIONS TO BE TAKEN WITH, SUCH EQUIPMENT.

UNPACKING AND INITIAL INSPECTION

Our Packing Department uses custom designed packaging to send out your unit, but as accidents can still happen in transit, you are advised, after unpacking the unit, to inspect it for any sign of shipping damage, and confirm that your delivery is in accordance with the packing note. If you find any damage or that part of the delivery is missing notify us or our agent, and the carrier immediately. If the unit is damaged you should keep the packing for possible insurance assessment.

ELECTRICITY SUPPLY

Before connecting to the electricity supply please familiarise yourself with the parts of the handbook relevant to your model.

Your unit's supply voltage requirement is specified on a plate on the instrument along with the serial number. All Venus^{Plus} instruments will work on an electricity supply frequency of 50Hz or 60Hz. The apparatus is provided with an approved power cord. If the plug is not suitable for your location then the plug should be removed and replaced with an appropriate plug.

Take care to ensure the old plug is disposed safely.



The cable is colour coded as follows:

<u>COLOUR</u>	<u>FUNCTION</u>
Green/yellow	Earth (Ground)
Brown	Live (line)
Blue	Neutral

Please ensure that your unit is correctly connected to the electricity supply.

THE APPARATUS MUST BE CORRECTLY EARTHED (GROUNDED)

The units on/off switch is located on the power inlet. Take care NOT to switch the unit off when it is hot - allow to cool first.

INTRODUCTION

The Isocal-6 range of products allows unprecedented flexibility for the calibration of temperature sensors. The Isocal-6 range may be used with the following options:

1. As a Metal Block Bath
2. As a Stirred Liquid Bath
3. As a Stirred Ice Bath
4. A Black Body Source
5. A Surface Sensor Calibrator
6. An ITS-90 Fixed Point Apparatus

COMPARISON CALIBRATION:

By definition, one compares industrial thermometers to a calibrated standard.

There are 3 methods commonly used.

1) BASIC

Using the controller as the “calibrated standard” this method means that the complete bath is calibrated by comparing the controller reading to a calibrated standard placed in the bath.

This is a common method but is unsafe since the control sensor is

- a) inaccessible
- b) in the wrong place to give correct temperature of the insert

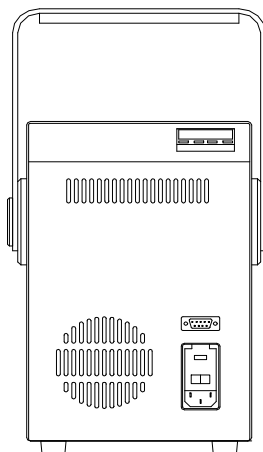

For these reasons it fails to satisfy ISO9000 and gives large uncertainties.

2) 'SITE' OR SELF-CONTAINED CALIBRATORS

In these an indicator and external calibrated sensor are used to measure the temperature of the insert. This arrangement gives good accurate and reliable results. To recalibrate however it does mean sending the whole calibrator back to the calibration laboratory. This, the calibrator is self-contained, self-sufficient and meets ISO9000 requirements.

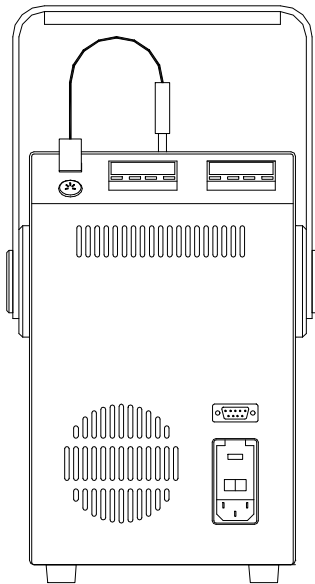

3) **EXTERNAL STANDARDS + BASIC**

Here a separate indicator and calibrated sensor are used to measure the inserts temperature. This can give the most accurate and reliable results, depending on the indicator.

It means that the calibrator does not need calibrating only the indicator and it's calibrated sensor need re-calibration, but this option is more bulky, expensive and less portable than 2) above. It also meets ISO9000 requirements.

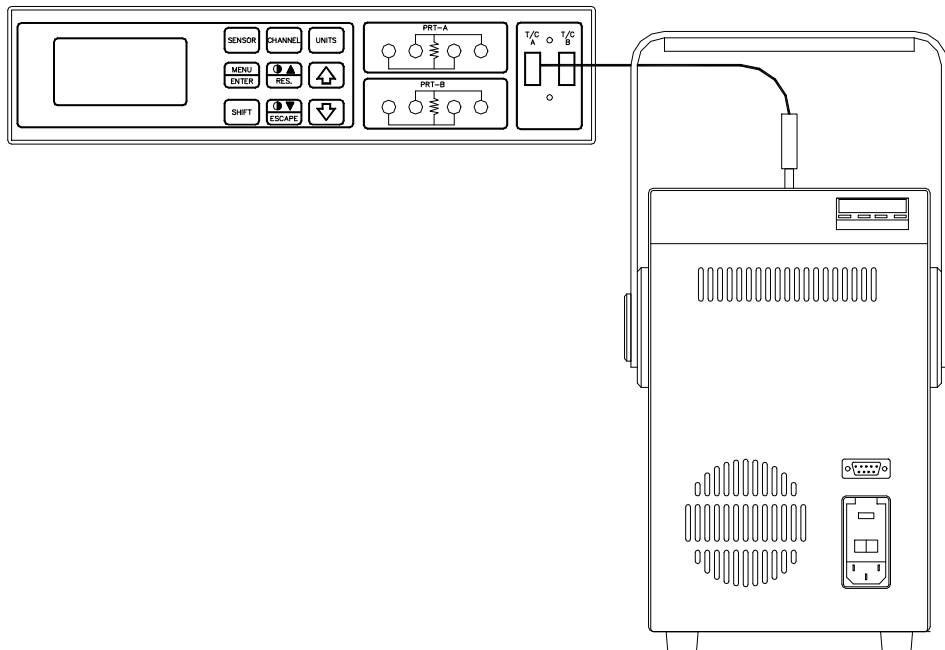

MODE OF OPERATION

1) METAL BLOCK BATH

The metal block bath function of the Isocal-6 is well suited for fast, convenient, mess free calibration of temperature sensors.

The Isocal-6 metal insert is placed into the calibration well. The stir speed control should be set to the OFF position (turn fully anti-clockwise).

The thermometers under test are placed into suitable holes in metal insert (part number 951-02-15), see accessory section page 35. For the S models a calibrated reference probe should be placed into the insert and the actual temperature can be read from the temperature indicator. For the B models an external temperature indicator should be used.

For traceable calibration the actual value of the insert temperature should be recorded along with the values from the sensors under test.

2) STIRRED LIQUID BATH

The stirred liquid bath function of the Isocal-6 is well suited for odd shaped sensors which will not easily be accommodated in a metal insert.

The Isocal-6 Liquid Container (part number 951-06-01) is placed into the calibration well and the container is filled with a suitable liquid, see accessory section page 35 for the temperature range that the bath is to be used over. The container should be filled to 25mm from the top of the tank. Care must be taken to adjust the level as the liquid contracts or expands with temperature changes. The stirrer speed control is set ON and to the mid position. If necessary the speed can be adjusted to give the optimum value for a particular application, this position should be found experimentally and then noted for future use.

The thermometers under test are placed into the liquid. Two accessories are available to support the thermometers.

- a) The Thermometer Support Kit (part number 951-06-03) allows thermometers with a diameter of 2 to 6.5mm to be suspended in the liquid.
- b) The Sensor Guide which fits into the tank and can support a number of thermometers (part number 951-02-24).

It is important that one of the accessories is used to prevent the probes from reaching the bottom of the tank which would stop the stirring action. For the S models a calibrated reference probe should be placed into the liquid and the actual temperature can be read from the temperature indicator. For the B models an external temperature indicator should be used. For traceable calibration the actual value of the liquid temperature should be recorded along with the values from the sensors under test.

3) **STIRRED ICE BATH**

The Stirred Ice Bath function is as the Stirred Liquid Bath. The liquid container - part number 951-06-01 - is filled with water, the stirrer speed control set to mid-position and the controller set to 0.0°C. Once the controller has stabilized at 0.0°C allow 10-15 minutes before starting calibration.

4) **BLACK BODY SOURCE**

The black body function of the Isocal-6 is well suited for fast, convenient, mess free calibration of infra-red temperature sensors.

The Isocal-6 black body target (part number 951-02-22), see accessory section page 35, is placed into the calibration well. The stir speed control should be set to the OFF position.

The units under test should be aligned with the target.

For the S models a calibrated reference probe should be placed into the hole in the block and the actual temperature can be read from the temperature indicator to which the infra red thermometer(s) are compared. For the B models an external temperature indicator should be used.

5) **SURFACE SENSOR CALIBRATION**

The surface sensor function of the Isocal-6 is well suited for fast, convenient, mess free calibration of most surface temperature sensors.

The Isocal-6 surface sensor insert (part number 951-02-19), see accessory section page 35, is placed into the calibration well. The stir speed control should be set to the OFF position.

A calibrated probe (part number 935-14-83) is placed in the pocket of the surface sensor insert and connected to the temperature indicator of the S models. For the B models an external indicator should be used. Surface sensors are placed on top of the insert and when stable compared to the calibrated probe.

6) **ITS-90 FIXED POINT CALIBRATION**

The ITS-90 fixed point function of the Isocal-6 is well suited for fast, convenient, mess free calibration of thermometers to uncertainties as low as 0.001°C.

The special cell is placed into the Isocal-6 calibration well. The stir speed control should be set to the OFF position. For detailed operating information, refer to the separate manual provided with the cell

HINT

HOW TO MEASURE THE TRUE TEMPERATURE INSIDE THE ACCESSORIES SUPPLIED WITH THE ISOCAL-6

The controller of the Isocal-6 controls and reads the temperature of the block surrounding the 35mm \varnothing by 160mm deep calibration well.

There are various accessories including the surface calibration insert, the oil container, black body etc. These adapt the Isocal-6 to perform varied calibration functions.

None of these accessories actually get to the block temperature and hence the controller's temperature because each accessory has a different immersion characteristic. For this reason the Isocal-6 like all comparison baths requires a reference thermometer to indicate the true temperature inside the accessory.

Remember the following:-

THE CONTROLLER

The controller is used to set a constant temperature and create an Isothermal environment for the comparison calibration of temperature sensors.

THE REFERENCE THERMOMETER

The Reference Thermometer is placed in the accessory or insert and measures the True Temperature inside the Insert or accessory.

THE INDUSTRIAL THERMOMETER

The Industrial Thermometer is placed in the accessory or insert and is compared to the True Temperature as indicated by the Reference Thermometer. An insert will typically have a 1% immersion error. For more details see - Depths of Immersion. Tavener J. P. Volume 9.2. Isotech Journal of Thermometry pages 79-87.

SPECIFICATION

Voltage	:	230VAC (<u>or</u> 115VAC) see ratings plate
Power	:	150W
Supply Frequency	:	50/60Hz
Maximum Operating Temperature	:	140°C
Minimum Operating Temperature	:	-55°C
Stability (Absolute over 30 Minutes)		
Metal Block Bath	:	±0.03°C
Stirred Liquid	:	±0.025°C
Ice/Water Bath	:	±0.001°C
Black Body Source	:	±0.3°C
Surface Sensor Calibrator	:	±0.5°C
ITS-90 Fixed Point Apparatus	:	±0.0005°C
Calibration Volume	:	35mm dia by 160mm deep
Standard Insert Hole Dimensions:	:	1 x 9.50mm dia + 1 x 8.00mm dia + 1 x 6.40mm dia + 1 x 4.50mm dia 1 x M4 tapped hole
Insert Options	:	Special drilling available to customer requirements.
Dimensions (not including handle)	:	Height 302mm Width 176mm Depth 262mm
Weight	:	10.2Kg

ISOCAL-6 PERFORMANCE GRAPHS

HEAT UP / COOL DOWN GRAPH ...

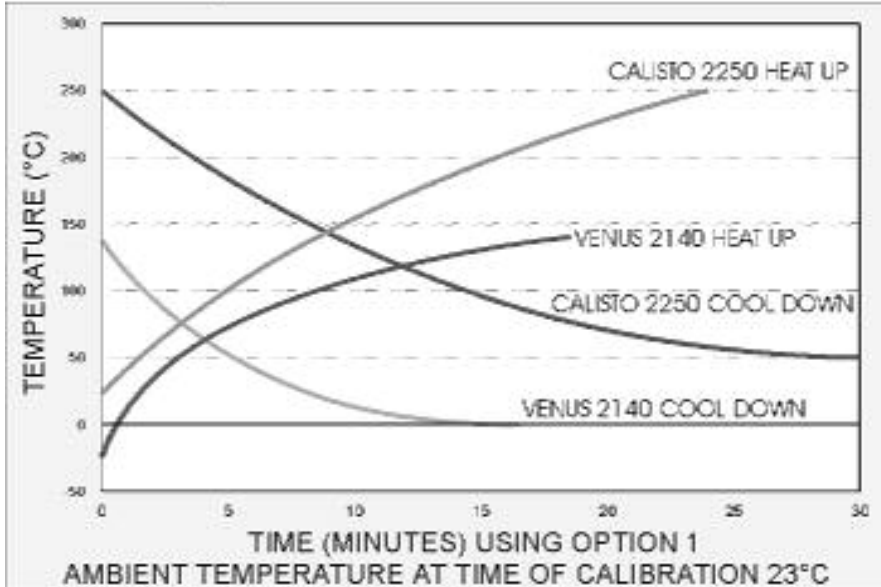

2 SIGMA UNCERTAINTIES GRAPH ...

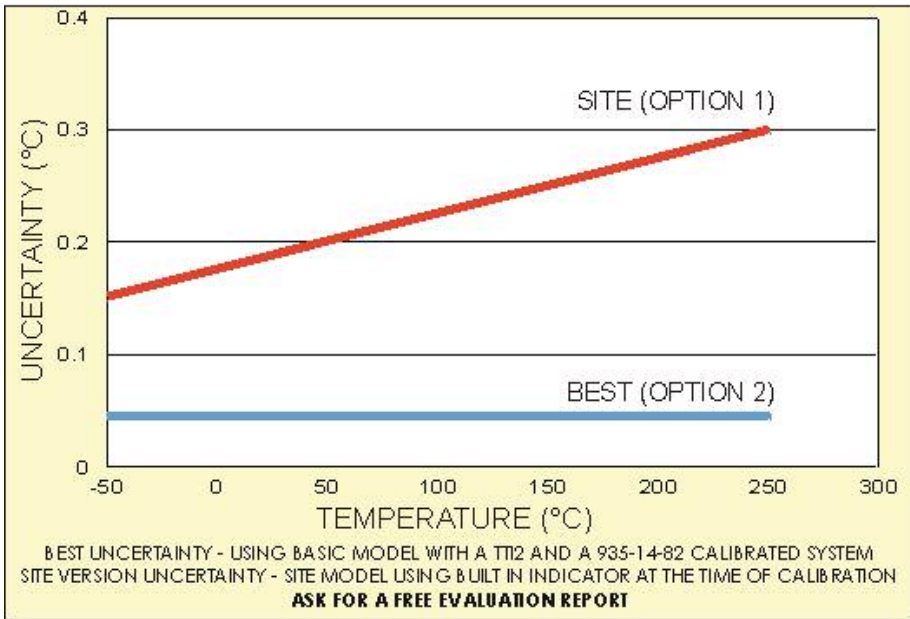

FRONT PANEL LAYOUT

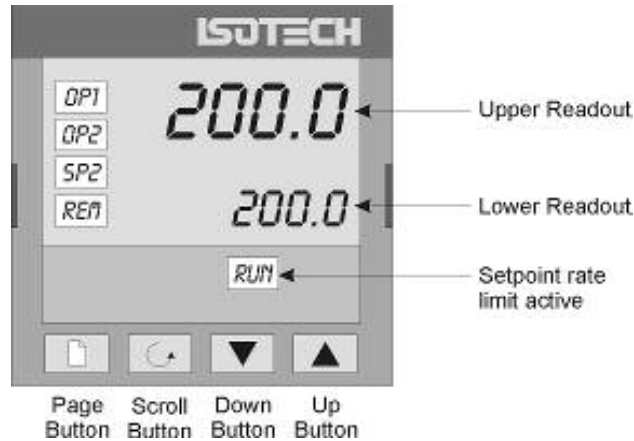

The Temperature

Controller

The controller has a dual display, the upper display indicates the nominal block temperature, and the lower display indicates the desired temperature or setpoint.

Altering the Setpoint

To change the setpoint of the controller simply use the UP and DOWN keys to raise and lower the setpoint to the required value. The lower display changes to indicate the new setpoint.

Advanced Controller Features

Setpoint Ramp Rate

By default the Dry Blocks are configured to heat (and cool) as quickly as possible. There may be some calibration applications where it is advantageous to limit the heating (or cooling rate).

An example might be when testing bimetallic thermostats, by forcing the Dry Block to heat at a controlled rate it is easier to determine the temperature at which the thermostat changes state.

The Dry Block can have its heating rate limited with the Setpoint Ramp Rate feature. This feature is accessed from the Scroll key. Depress the key until the display shows,

SPrr

On the Upper Display, the lower display will show the current value from OFF (default) to 999.9.

The desired rate is set here with the UP and DOWN keys, the units are °C/min.

When the SPrr is active the controller display will show "RUN", the lower setpoint display will now automatically update with the current value, known as the working setpoint. The setpoint can be seen by pressing either the UP and DOWN key.

The Setpoint ramp rate operates when the bath is heating and cooling.

Instrument Address

The controller has a configurable "address" which is used for PC communications. Each instrument has an address, this allows several instruments to be connected in parallel on the same communications bus. The default value is 1. This address would only need to be changed if more than one Dry Block is connected to the same PC port.

To check the Address value press the scroll key until the top display indicates,

Addr

The lower display will show the current value that can be modified with the UP and DOWN keys.

Monitoring the Controller Status

A row of beacons indicate the controllers status as follows,

OP1	Heat Output
OP2	Cool Output (Only for models which operate below 0°C)
REM	This beacon indicates activity on the PC interface

For models fitted with cool down fans, such as the Calisto and Jupiter, the lower display will alternate between the setpoint and the message, 1dHi. This message is not an error but is showing that the cooling fan is operating. It will automatically switch off when the temperature is within 5°C of the setpoint.

Units

Momentary pressing the Scroll key will show the controller units °C or °F.

The Temperature Indicator (Site (S) Models Only)

The site models include an electronic temperature indicator. The indicator can be configured for the desired sensor type, and for custom calibration data. The customer calibration data can be set ON or OFF.

Setting the Input Type

A 100 Ohm resistance thermometer can be connected to the PRT Connector or a thermocouple may be connected to the miniature TC Connector.

Ensure that only a PRT or a TC is connected at any one time. If a PRT and TC are



connected simultaneously the indicator will read in error.

Check that any sensor placed into the Venus^{Plus} is suitable for the temperature range. Sensors can be damaged if taken outside their normal operating limits.

The desired sensor type is easily set, press the Scroll key until the upper display indicates,

inPt

On the upper display. The lower display will show the current set sensor type,

J.tc	J thermocouple
K.tc	K thermocouple
L.tc	L thermocouple
r.tc	R thermocouple (Pt/Pt13%Rh)
b.tc	B thermocouple (Pt30%Rh/Pt6%Rh)
n.tc	N thermocouple
t.tc	T thermocouple
S.tc	S thermocouple (Pt/Pt10%Rh)
PL.2	PL 2 thermocouple
rtd	100Ω platinum resistance thermometer.
T012	E thermocouple

Again the value can be modified with the UP and DOWN keys.

Enabling / Disabling Custom Calibration

Custom calibration allows the indicator to be programmed to suit a particular temperature sensor. This allows the indicator to automatically show the true temperature, without having to manually apply a correction.

When the Custom or User Calibration is active the indicator will show the REM beacon lit continuously. The use of User calibration can make a significant difference to the accuracy of the instrument, and this REM beacon provides a clear and continuous indication of the calibration status. Isotech will configure and set user calibration when the Dry Block is ordered with a temperature sensor.

To alter the calibration status press the Scroll key until the upper display shows,

CAL

The lower display will indicate either,
USEr for user calibration

Or

FACT for factory calibration of the indicator, i.e. User Cal OFF

Use the UP and DOWN keys to toggle between the two values.

When calibrating an unknown sensor against a calibrated probe it may be necessary to switch the calibration off for the unknown, and on for the calibrated probe.

Instrument Address

Like the controller, the indicator has a configurable "address" which is used for PC communications. Each instrument has an address; this allows several instruments to be connected in parallel on the same communications bus. The default value is 2 (The controller defaults to 1). This address would only need to be changed if more than one Dry Block is connected to the same PC port.

To check the Address value press the scroll key until the top display indicates,

Addr

The lower display will show the current value that can be modified with the UP and DOWN keys.

Monitoring the Indicator Status

For the indicator the REM beacon is lit continuously when the user calibration is active, the REM beacon flashes when the PC communications port is active.

Units

Momentary pressing the Scroll key will show the controller units °C or °F.

Advanced Indicator Operation

The indicator can be configured with up to five custom calibration points; the points contain "data pairs". First the temperature (point) and secondly the Error (offset) at this temperature point. Isotech Dry Block calibration certificates will show the values to suit a particular sensor.

These values can be inspected, and modified with the following procedure,

Press the PAGE key until the display indicates,

ACCS
LiSt

Press the SCROLL key until the display shows,

Goto
OPeR

Press the UP key until the display shows

Goto
conF

Press the Scroll Key twice, when the display will show,

inSt
Conf

Press the Page Key until the controller shows

CAL
Conf

Now use the Scroll key to examine the data pairs. The values can be modified with the UP and DOWN keys.

To exit this mode press the Page key until the top display shows,

Exit

And then set the lower display to YES. While in this mode take care not to modify other parameters - a full list of all the parameters can be found in appendix 2.

CALIBRATION DATA EXAMPLE

A maximum of five points may be entered, shown as Pnt 1 to Pnt 5 for the temperature point and Ofs 1 to Ofs 5 for the offset values.

The Pnt values must be entered in ascending order.

Set a Pnt to a value lower than the previous point to disable it.

The indicator would be programmed with the following data:

Pnt 1	100	Ofs 1	0.8
Pnt 2	300	Ofs 2	1.1
Pnt 3	500	Ofs 3	2.1
Pnt 4	-999	Ofs 4	0
Pnt 5	-999	Ofs 5	0

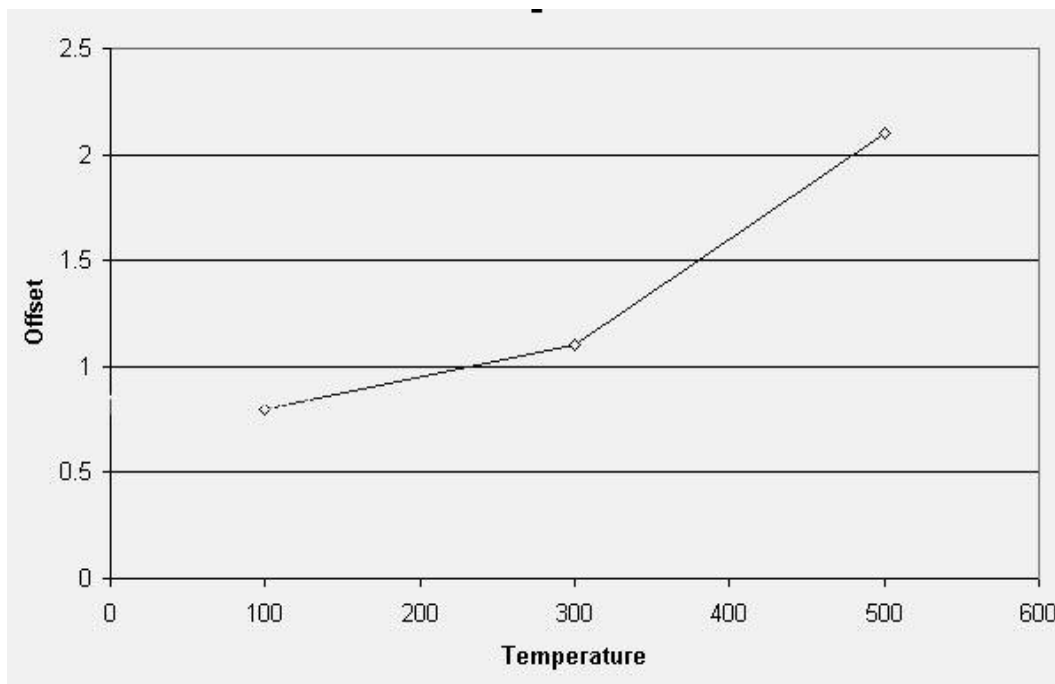

CONNECTING A CURRENT TRANSMITTER (UP TO 20MA)

The transmitter should be powered externally, a 2.49Ω current sense resistor is fitted internally and this allows the indicator to read mA.

1. From the input type menu select "mV".
2. Access configuration level.

SELECTING CONFIGURATION LEVEL

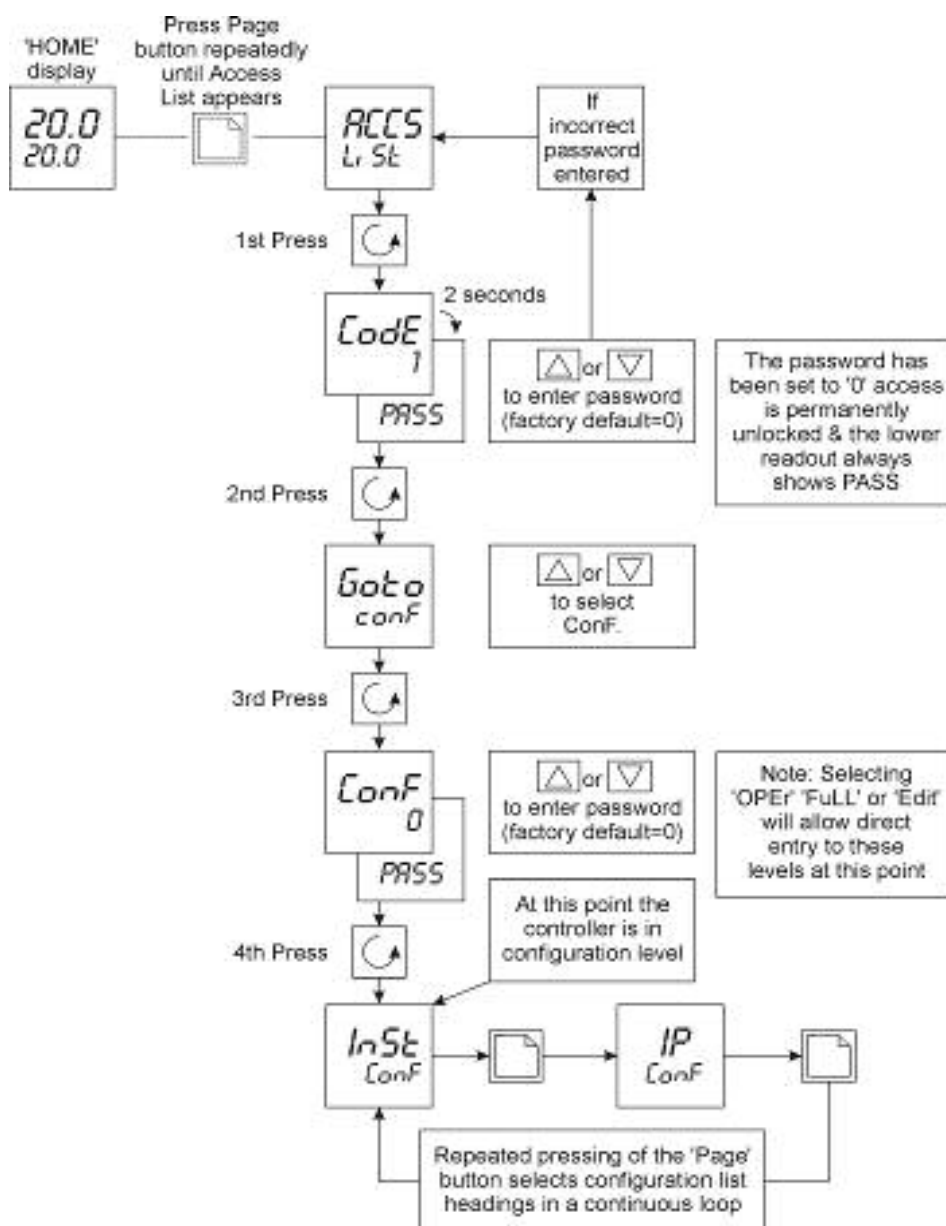

From the input menu iP set the inP.L, inP.H, VAL.L and VAL.H parameters to suit see table below;

Linear Input Scaling - The next 4 parameters only appear if a linear input is chosen

e.g. 4 to 20mA = 0 to 100°C

	inP.L	Input value low	i.e. 4mA set 9.96
	inP.H	Input value high	i.e. 20mA set 49.8
	VAL.L	Displayed reading low	0°C
	VAL.H	Displayed reading high	100°C

E.g. 4-20mA = 0 to 100°C

inP.L	=	9.96 (mV)	(4mA x 2.49Ω)
inP.H	=	49.8 (mV)	(20mA x 2.49Ω)
VAL.L	=	0 (°C)	
VAL.H	=	100 (°C)	

Exit config level by pressing PAGE key until the top display shows Exit, use the UP key to select YES, after two seconds the instrument will reset.

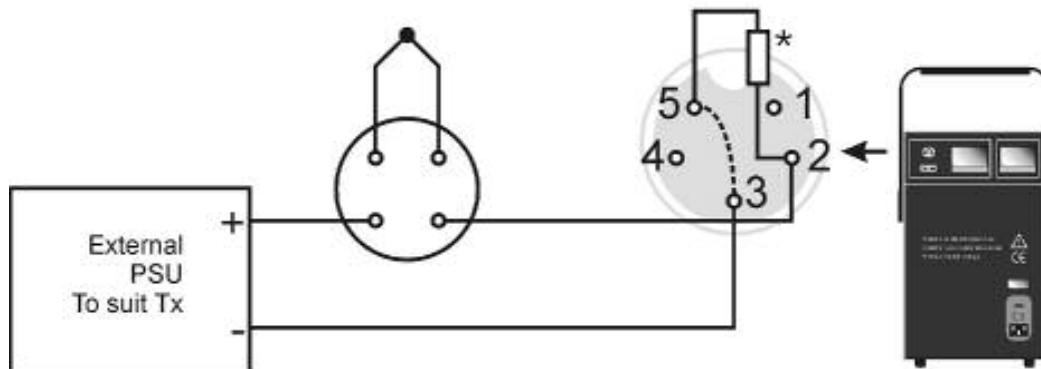

*2.49Ω resistor fitted internally (Pins 2 and 5).

Link Pins 3 and 5 for transmitter inputs.

Remove link for T/C's and PRT's.

Socket Pins shown from Panel View

Using the PC Interface

The Plus models include an RS422 PC interface and a special converter cable that allows use with the a standard RS232 port. When using the bath with an RS232 port it is essential that this converter cable is used. Replacement cables are available from Isotech, part number ISO-232-432. A further lead is available as an option, Part Number ISO-422-422 lead which permits up to 5 instruments to be daisy chained together.

The benefit of this approach is that a number of calibration baths may be connected together in a "daisy chain" configuration - and then linked to a single RS232, see diagram.



Note: The RS 422 standard specifies a maximum lead length of 1200M (4000ft). A true RS422 port will be required to realise such lead lengths. The Isotech conversion leads are suitable for maximum combined lead lengths of 10M that is adequate for most applications.

Connections

For RS232 use simply connect the Isotech cable, a 9 to 25 pin converter is included to suit PCs with a 25 pin serial converter.

RS422 Connections

Pin	Connection
4	Tx+ A
5	Tx- B
8	Rx+ A
9	Rx- B
1	Common

Using the Interface

The models are supplied with Cal NotePad as standard. This easy to use package is compatible with MS Windows 9x. A handbook for Cal NotePad can be found on the first installation disk in Adobe PDF format. If required a free Adobe PDF reader can be downloaded from, www.adobe.com.

CAL NOTEPAD

Cal Notepad can be used to log and display values from the Dry Blocks and an optional temperature indicator.

Minimum System Requirements

CNP requires Windows 95 / 98, a minimum of 5Mb of free hard drive space and free serial ports for the instruments to be connected.

Development

CNP was developed by Isothermal Technology using LabVIEW from National Instruments.

License

Use of the Cal NotePad software program "CNP" is as granted in this license agreement. In using the CNP

software the user "licensee" is agreeing to the terms of the license. You must read and understand the terms of this license before using CNP.

1, This license permits licensee to use CNP software on a single computer. The user may make copies for back up and archival purposes freely as long as the software is only ever in use on a single computer at any one time. Please enquire about multi-user licenses.

2, CNP is protected by international copyright laws and treaties. CNP must not be distributed to third parties.

3, CNP must not be reversed engineered, disassembled or de-compiled. Licensee may transfer the software to a third party provided that no copies or upgrades of CNP are retained.

4, It is the responsibility of the user to ensure the validity of all stored results and printed certificates. Isothermal Technology Ltd accept no responsibility for any errors caused by inappropriate use, incorrect set up or any other cause; including defects in the software.

5, Limited Warranty. Isothermal Technology warrants that CNP will perform substantially as described in this manual for a period of 90 days from receipt. Any distribution media will under normal used be guaranteed for a period of 90 days.

NO OTHER WARRANTIES, EXCEPT AS STATED ABOVE. The software and documentation is provided "as is" without warranty of any kind and no other warranties (either expressed or implied) are made with regard to CNP. Isothermal Technology does not warrant, guarantee or make any representations regarding the use or results of the use of the software or documentation and does not warrant that the operation of CNP will be error free.

In no event will Isothermal Technology, its employees, agents or other associated people be liable for direct, indirect, incidental or consequential damages, expenses, lost profits, business interruption, lost business information or other damages arising out the use or inability to use CNP. The license fee reflects this allocation of risk.

CNP is not designed for situations where the results can threaten or cause injury to humans.

Installing Cal NotePad

1. Insert CNP DISK 1 into the disk drive
2. Click on the START button on the task bar, select RUN, type A:\SETUP (Where A: is your drive letter) then click OK
3. Follow the prompts which will install the application and necessary LabVIEW run time support files.
4. Should you ever need to uninstall the software then use the Add/Remove Programs option from the Control Panel.

Starting Cal NotePad

From a Standard Installation:

Click the START button

Highlight PROGRAMS

Select Isotech - Select Calpad

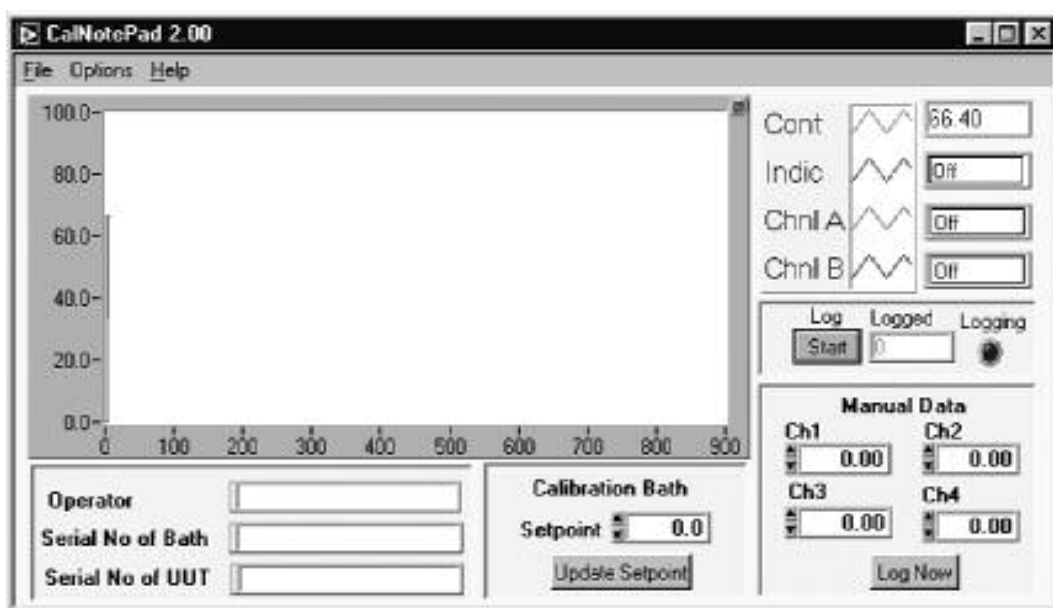

Protocol

The instruments use the "Eurotherm EI BiSynch Protocol"

If required, e.g. for writing custom software the technical details are available from our website at, www.isotech.co.uk/refer.html

Diagnostic alarms

These indicate that a fault exists in either the controller, indicator or the connected sensor.

Controller Error Messages

The instruments include powerful diagnostics and in the unlikely event of an internal failure, or a sensor error, one of the following error messages may be displayed.

Display shows	What it means	What to do about it
EE.Er	<i>Electrically Erasable Memory Error:</i> The value of an operator or configuration parameter has been corrupted	For Controller: Contact Isotech For Indicator: Check Config Against Data in Appendix
S.br	<i>Sensor Break:</i> Input sensor is unreliable or the input signal is out of range.	For Controller: Contact Isotech For Indicator: Check a sensor is connected. Check that only a PRT or a TC is Connected (Not both)
HW.Er	<i>Hardware error :</i> Indication that a module is of the wrong type, missing or faulty	Contact Isotech
LLLL	<i>Out of Display range, low reading</i>	For Controller: Contact Isotech For Indicator: Check Sensor and Connections
HHHH	<i>Out of Display range, high reading</i>	For Controller: Contact Isotech For Indicator: Check Sensor and Connections
Err1	<i>Error 1: ROM self-test fail</i>	Consult Isotech
Err2	<i>Error 2: RAM self-test fail</i>	Consult Isotech
Err3	<i>Error 3: Watchdog fail</i>	Consult Isotech
Err4	Error 4: Keyboard failure Stuck button, or a button was pressed during power up.	Switch the power off and then on without touching any of the controller buttons.
Err5	<i>Error 5: Input circuit failure</i>	Consult Isotech
Pwr.F	<i>Power failure.</i> The line voltage is too low	Check that the supply to the controller is within the rated limits

INITIAL TESTING

This unit was fully tested before despatch to you but please check its operation as outlined below.

After connecting the Venus^{Plus} 2140 to the electricity supply, the temperature controller display will show the temperature of the block and the last set-point value. The S controller and indicator both go through a self-test sequence first. The fan on the front panel should be heard running.

Change the set-point to 50°C and observe that the block temperature rises and settles to this value. For the S; place a thermometer in an insert in the block and connect it to the suitably configured indicator. Confirm that the indicator agrees within $\pm 2^{\circ}\text{C}$ of the controller.

Your unit should have performed as described above and can now be used for calibration.

If any problems or faults arise during these tests please contact us or our agents for help and advice.



IMPORTANT NOTICE

The controller's function settings are preset and will not require adjustment.

MAINTENANCE

Maintenance is limit to keeping the apparatus and the calibration volume clean and free from debris.

There are no internal user serviceable parts.

Repair and maintenance must be carried out by Isothermal Technology Limited or an approved agent.

FIGURE 1

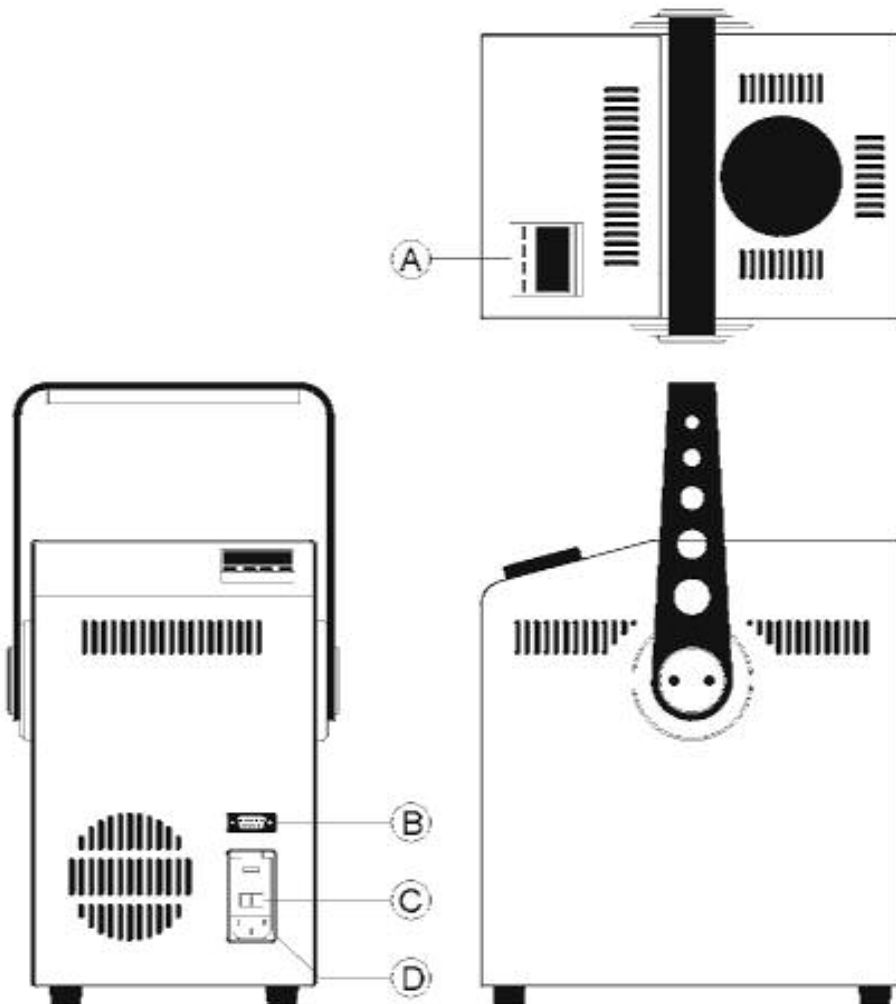

- Ⓐ Temperature Controller
- Ⓑ PC Interface
- Ⓒ On/Off Switch
- Ⓓ Power Entry and Fuse

FIGURE 2

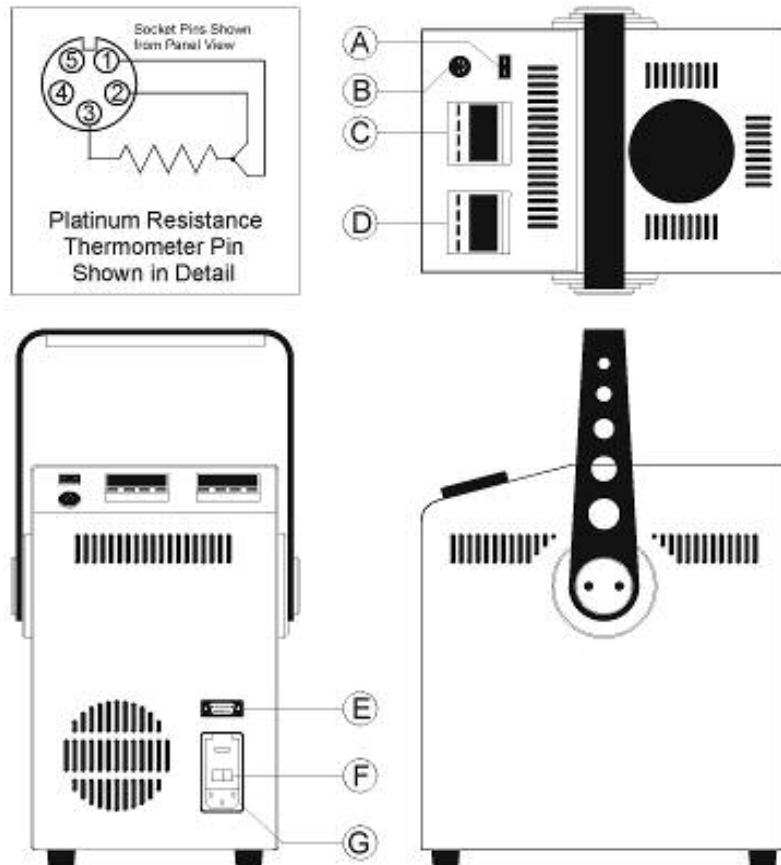

- (A) Thermocouple Connector
- (B) Platinum Resistance Thermometer Connector
- (C) Temperature Indicator
- (D) Temperature Controller
- (E) Communications Connector (optional)
- (F) On/Off Switch
- (G) Power Entry and Fuse

 **NOTE:** Only connect a thermocouple or platinum resistance thermometer to the input connectors. Ensure that only one sensor is connected at any one time.

APPENDIX 1

VENUS^{PLUS} 2140

TROUBLE SHOOTING

1. Unit fails to operate

Check fuse, Figure 1, page 32. If fuse blows repeatedly consult Isotech or local agent.

2. Will not control at 30°C

Check room temperature. Minimum operating temperature of 35°C is for a room temperature of 20°C.

3. Indicator reads incorrectly

Two sensors connected simultaneously.
Indicator incorrectly configured - see pages 19 to 23.

4. Unit unstable

Control parameters have been interfered with - consult your local agent.

5. Cannot establish PC Communications

For RS232 you must use the Isotech adaptor cable.
Ensure the addresses of the controller and indicator match those set in Cal Notepad.
Ensure each controller and indicator are set to a unique address.
Refer to 'Using the PC Interface' section and the Cal Notepad manual for further details.

APPENDIX 2

INDICATOR CONFIGURATION (Reference Only)

Config.INST

Name	Description	Value
unit	Instrument Units	°C (0)
dEcP	Decimal Places in Display	NN.NN
Ctrl	Control Type	PID (0)
Act	Control Action	REV (0)
COOL	Cooling Type	LIN (0)
PwrF	Power Feedback Enable	OFF (0)
Pdtr	Manual/Auto Transfer PD Control	NO (0)
FoP	Forced Output Enable	NO (0)
Sbrt	Sensor Break Type	SB.OP (0)
rnGH	Process Value High Limit	670
rnGL	Process Value Low Limit	0.00

Config.IP

Name	Description	Value
inPt	Linearisation Type	RTD
CJC	CJC Type	(EXT)
imP	Sensor break impedance	AUTO (1)

Config.CAL

Name	Description	Value
UCAL	User Calibration Enable	YES (1)
Pnt1	User Cal Point 1	0
Pnt5	User Cal Point 5	-99.00
OFS1	User Cal Offset 1	0.00
Pnt2	User Cal Point 2	-99
OFS2	User Cal Offset 2	0.00
Pnt3	User Cal Point 3	-99
OFS3	User Cal Offset 3	0.00
Pnt4	User Cal Point 4	-99.00
OFS4	User Cal Offset 4	0.00
OFS5	User Cal Offset 5	-99.00

Note: User Cal values are unique to each instrument. If available set values to those from calibration certificate

Config.AL

Name	Description	Value
AL_1	Alarm 1 Type	OFF (0)
Ltch1	Alarm 1 Latching	NO (0)
AL_2	Alarm 2 Type	OFF (0)
Ltch2	Alarm 2 Latching	NO (0)
AL_3	Alarm 3 Type	OFF (0)
Ltch3	Alarm 3 Latching	NO (0)
AL_4	Alarm 4 Type	OFF (0)
Ltch4	Alarm 4 Latching	NO (0)

Config.HA

Name	Description	Value
id	Module Identity	CMS (7)
Func	Module Function	CMS (65)
bAud	Baud Rate	9600 (0)
Prty	Comms Parity	NONE (0)
rES	Comms Resolution	FUL (0)

Config.1A

Name	Description	Value
id	Module Identity	LOG (3)
Func	Module function	NONE (0)
SEnS	Sense of Output	NOR (0)

Config.2A

Name	Description	Value
id	Module Identity	LOG (3)
Func	Module function	NONE (0)
SEnS	Sense of Output	NOR (0)

APPENDIX 3
ACCESSORIES PARTS LIST

OPTION 1

Standard Dry Block Insert 951-02-15

OPTION 2 & 3

Liquid Container Kit 951-06-01
Liquid Container 951-02-21
PTFE Collar 951-02-23
Magnetic Followers 932-12-55
Sealing Collar (O Ring) 932-12-57
Sensor Guide 951-02-24
Liquid in Glass Thermometer Support Kit 951-06-03
Gantry 951-02-18
Blank Disc 951-02-20A
Drilled Disc 951-02-20
3 x Gantry Plugs 820-20-24
3 x O Seals 932-12-49

OPTION 4

Black Body Target 951-06-04

OPTION 5

Surface Sensor Insert Calibrator Kit 951-06-02
Surface Sensor Insert 951-02-19
Surface Sensor Probe 935-14-83

OPTION 6

Slim Gallium Cell 17401M
Slim Water Triple Point Cell D8

C20 Oil 951-06-06
Standard Probe for On-site Model 935-14-82
Carrying Case 931-22-27

**LIQUID IN
GLASS
THERMOMETER
SUPPORT
KIT - 951-06-03**

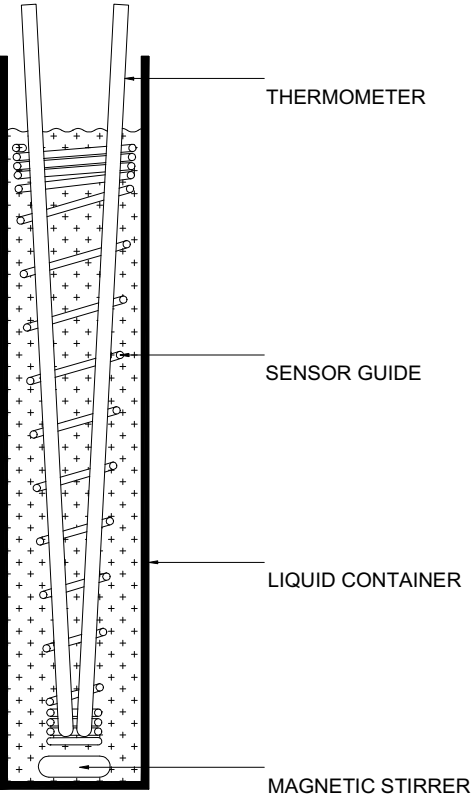
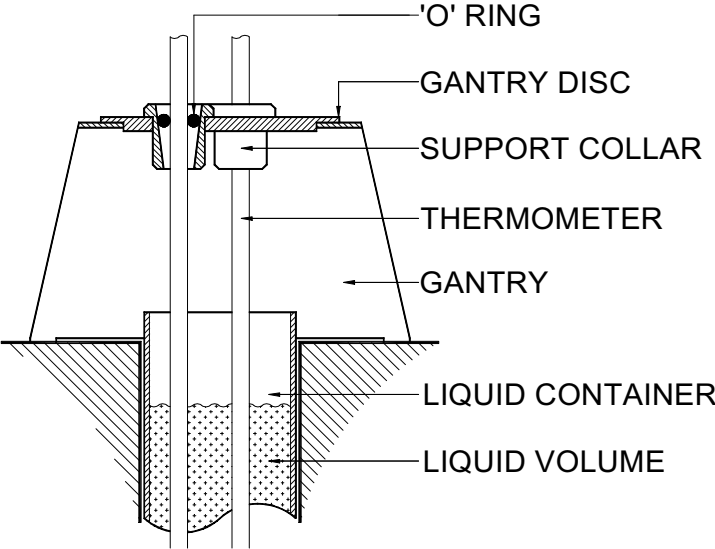

**LIQUID
CONTAINER
KIT - 951-06-01**