

**PRECISION PLATINIUM
RESISTANCE THERMOMETER
MODEL 670 SH & SL**
User Maintenance Manual/Handbook

Isothermal Technology Limited, Pine Grove, Southport, PR9 9AG, England
Tel: +44 (0) 1704 543830 Fax: +44 (0) 1704 544799 Internet: www.isotech.co.uk E-mail: info@isotech.co.uk

The company is always willing to give technical advice and assistance where appropriate. Equally, because of the programme of continual development and improvement we reserve the right to amend or alter characteristics and design without prior notice. This publication is for information only.

GUARANTEE

© Isothermal Technology Limited

This instrument has been manufactured to exacting standards and is guaranteed for twelve months against electrical breakdown or mechanical failure caused through defective material or workmanship, provided the failure is not the result of misuse.

In the event of failure covered by this guarantee, the instrument must be returned, carriage paid, to the supplier for examination and will be replaced or repaired at our option.

FRAGILE CERAMIC AND/OR GLASS PARTS ARE NOT COVERED BY THIS GUARANTEE INTERFERENCE WITH OR FAILURE TO PROPERLY MAINTAIN THIS INSTRUMENT MAY INVALIDATE THIS GUARANTEE

The company is always willing to give technical advice and assistance where appropriate. Equally, because of the programme of continual development and improvement we reserve the right to amend or alter characteristics and design without prior notice. This publication is for information only.



Isothermal Technology Limited

Pine Grove, Southport, Merseyside, PR9 9AG, England

Telephone: +44 (0)1704 543830/544611 / Fax: +44 (0)1704 544799

Email: info@isotech.co.uk / Website: www.isotech.co.uk

CONTENTS

⚠ CAUTIONARY NOTE 4

SPRT UNPACKING INSTRUCTIONS WHEN PACKED IN WOODEN TRANSPORT CRATE 912-00-005

SPRT UNPACKING INSTRUCTIONS WHEN PACKED IN WOODEN TRANSPORT CRATE 931-22-128
..... 6

DESCRIPTION 7

GENERAL USE 7

ANNEALING..... 7

SEVERE SHOCKS OR VIBRATION 7

OPERATING INSTRUCTIONS..... 8

RETURNING YOUR THERMOMETER TO ISOTECH..... 9

APPENDIX I..... 10

THE LONG TERM PERFORMANCE OF A 670 THERMOMETER..... 13

INTRODUCTION 13

RESULTS 13

CONCLUSION..... 13

UKAS ACCREDITATION SCHEDULE ISSUE 037 14

SPRT REPACKING INSTRUCTIONS USING THE WOODEN TRANSPORT CRATE 912-00-00 17

SPRT REPACKING INSTRUCTIONS USING THE WOODEN TRANSPORT CRATE 931-22-128..... 18

SPRT REPACKING INSTRUCTIONS USING THE CARDBOARD CARTON 19

 CAUTIONARY NOTE

ISOTECH PRODUCTS ARE INTENDED FOR USE BY TECHNICALLY TRAINED AND COMPETENT PERSONNEL FAMILIAR WITH GOOD MEASUREMENT PRACTICES.

IT IS EXPECTED THAT PERSONNEL USING THIS EQUIPMENT WILL BE COMPETENT WITH THE MANAGEMENT OF APPARATUS WHICH MAY BE POWERED OR UNDER EXTREMES OF TEMPERATURE, AND ARE ABLE TO APPRECIATE THE HAZARDS WHICH MAY BE ASSOCIATED WITH, AND THE PRECAUTIONS TO BE TAKEN WITH, SUCH EQUIPMENT.

SPRT UNPACKING INSTRUCTIONS WHEN PACKED IN WOODEN TRANSPORT CRATE 912-00-00

In the event that this SPRT has been transported by courier in the specially designed wooden transport crate you must follow the unpacking instructions.

Please keep this crate and all its internal pieces should the SPRT be required to be returned.

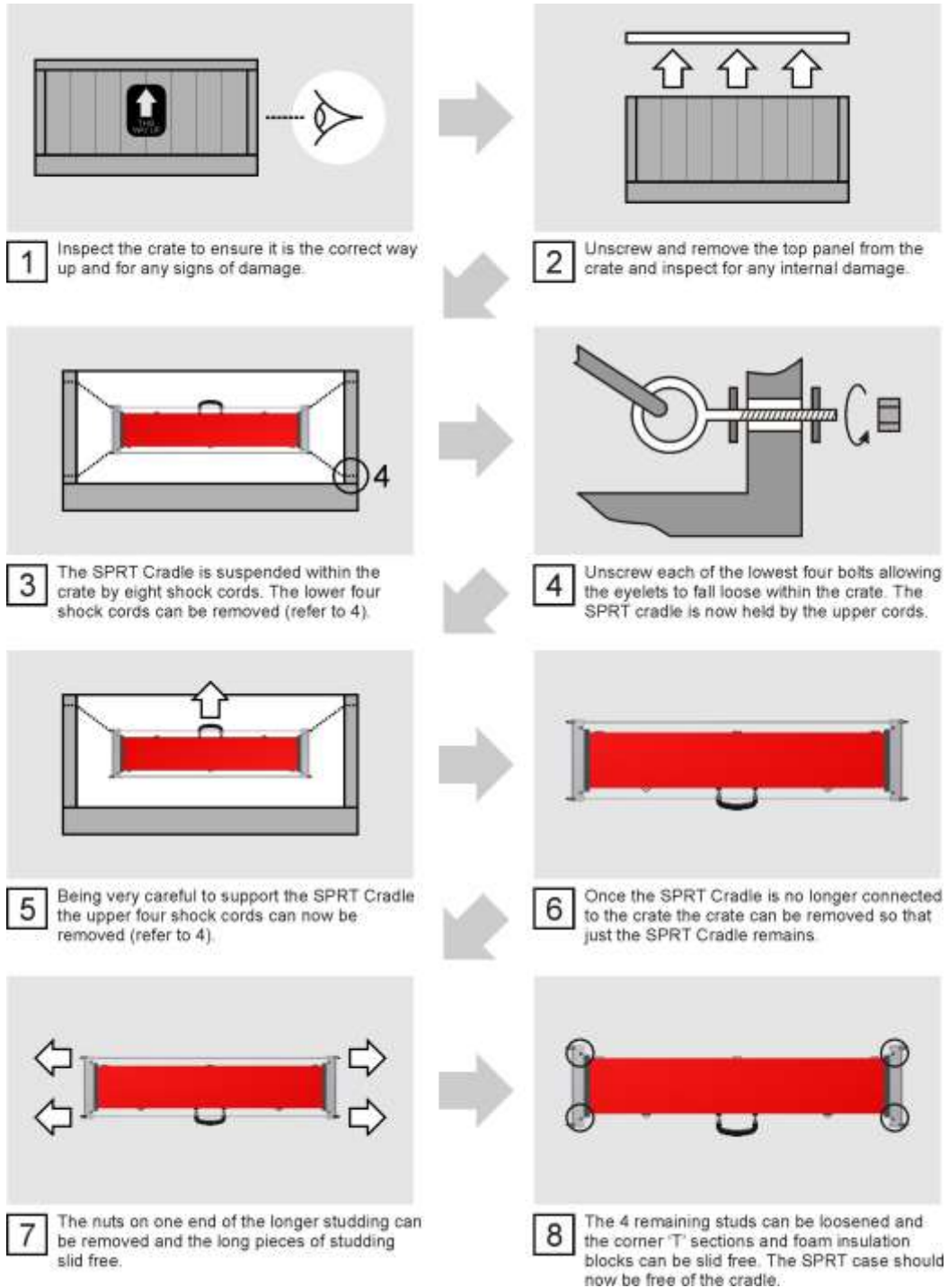

DO NOT DISCARD THE CRATE AND ITS INTERNAL PIECES – IT CAN BE REUSED

SPRT UNPACKING INSTRUCTIONS WHEN PACKED IN WOODEN TRANSPORT CRATE 931-22-128

In the event that this SPRT has been transported by courier in the specially designed wooden transport crate you must follow the unpacking instructions.

Please keep this crate and all its internal pieces should the SPRT be required to be returned.



- 1** Visually inspect the wooden crate to ensure it is the correct way up and for any signs of damage, if the shock/tilt watch labels have been activated this must be noted to the carrier preferably on delivery.



- 2** Unscrew and remove the top panel to reveal the inner cardboard carton which is holding the SPRT in its storage case.



- 3** The inner carton is attached and permanently suspended by pre-fixed elastic cords and sealed by two velcro straps. **DO NOT CUT OR TRY TO REMOVE THE ELASTIC CORDS OR STRAPS.**



- 4** To open the inner carton lid carefully undo the velcro straps.



- 5** The SPRT case is held inside the carton with poly end foam blocks.



- 6** Supporting the SPRT case from underneath very carefully lift from the carton and remove the poly end foam blocks from the SPRT case.

DO NOT DISCARD THE CRATE AND ITS INTERNAL PIECES – IT CAN BE REUSED

DESCRIPTION

The 670 is our best SPRT. The platinum winding is supported on a quartz cross similar to the Meyers design (which uses a micra cross). Two platinum lead wires from the winding are restively welded to 4 platinum wires, each of which run up individual fine bore quartz tubes to the hand area where they are secured to a 4 core cable which runs to the measuring instrument.

The 670 is vacuumed and back filled with a dry mixture of oxygen and argon according to recommendations made in Supplementary Information to the ITS-90.

The resistance at 0°C (R_0) of the 670 can be 25.5Ω (recommended) or 100Ω. W_{ga} is ≥ 1.11807 as specified in the ITS-90. The 670 will work from -200°C to +670°C and can be supplied either with R_{TPW} and W_{ga} or with UKAS calibration to one of the ranges specified in Databook 5.

GENERAL USE

Once calibrated your 670 will maintain its W values provided it is fully annealed.

Depending on use (Time and Temperature). R_{TPW} will change and should be monitored regularly.

Damage to the platinum winding can occur due to shock and/or vibration. Small amounts of strain in the winding will show as an increase in R_{TPW} and can be restored by annealing.

SPRT's are subject to oxide effects which can cause large positive shifts in R_{TPW} , again annealing should remove the oxide.

ANNEALING

Using a annealing furnace slowly heat the SPRT to its maximum temperature then hold it there for 2 to 3 hours, before setting the temperature down to around 450°C and allowing the SPRT to slowly cool with the furnace. Leave the SPRT at 450°C for half an hour and remove into air at room temperature.

Check R_{TPW} and repeat if necessary.

SEVERE SHOCKS OR VIBRATION

Can cause individual coils of the winding to touch. This is noted as a very large drop in R_{TPW} .

OPERATING INSTRUCTIONS

This instrument has taken many hours to prepare, manufacture and calibrate. To get the best results from such an instrument it is necessary to treat it with care, love and understanding.

Treat it as you would a piece of Dresden, Capo-di-Monte or Minton China.

- a) Have a special place in which it can be stored
- b) Do not drop or knock
- c) Do not put lateral pressure on the stem; it is rigid and will break, not bend
- d) Support by clamping the PTFE handle between soft jaws
- e) The handle and top 40mm of stem should not be heated over 50°C
- f) The cable will withstand 200°C
- g) Always pre-clean the quartz sheath before use with alcohol and dry thoroughly.

To keep the original characteristics:

1. Do not use the SPRT in conditions where there is vibration or mechanical shock.
2. Avoid thermal shock - allow the SRPT to warm-up and cool-down slowly.
3. Do not exceed the temperature limits -200°C to +670°C.
4. If used above 450°C, eg. at Aluminium (660°C) temperature always cool slowly to 450°C, then maintain at 450°C for approximately ½ hour, and then withdraw to ambient.
5. Always cool a hot SPRT in a thermometer rack where the SPRT can cool in an upright position, never cool in a horizontal position.

To obtain best results, the immersion recommendations given in Appendix I should be observed.

The cable is connected as follows:

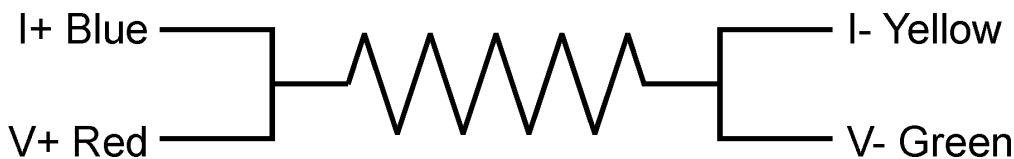

RETURNING YOUR THERMOMETER TO ISOTECH

The Model 670 is an extremely fragile SPRT and we strongly recommend that this it is personally hand carried , however due to strict customs procedures imposed worldwide this is not always possible.

In the event that this SPRT has to be transported by courier one of our specially designed wooden transport crates with or the original cardboard carton will have been used.

In all instances we recommend that you keep the packing and all its internal pieces.

Full re-packing instructions can be found later in the manual.

APPENDIX I

One of the principal difficulties encountered in making high precision measurements with long stem thermometers is that resulting from poor immersion characteristics of the thermometer. The relatively poor thermal contact between the thermometer element and the surroundings, together with the conduction and radiation down the stem, call for a very deep immersion. Figure 2 shows how the measured temperature for this particular design of thermometer depends upon immersion in a triple-point-of-water cell. The immersion characteristics are noticeably different for the different types of thermometer and as we would expect, depend upon how close the platinum wire is to the walls of the stem. The heating effects found in the three types of thermometer shown Figure 1 (a, b and c) in a triple-point-of-water cell are 1mK, 3mK and 1mK respectively for a 1mA measuring current.

It is worth remarking here that if the ultimate in reproducibility is being sought, better than 20uK for example, it is the stability of the heating effect that is likely to be the limiting factor. This arises because it becomes increasingly difficult to maintain the constancy of thermal contact between the resistance wire and the surrounding medium as the temperature resolution increases.

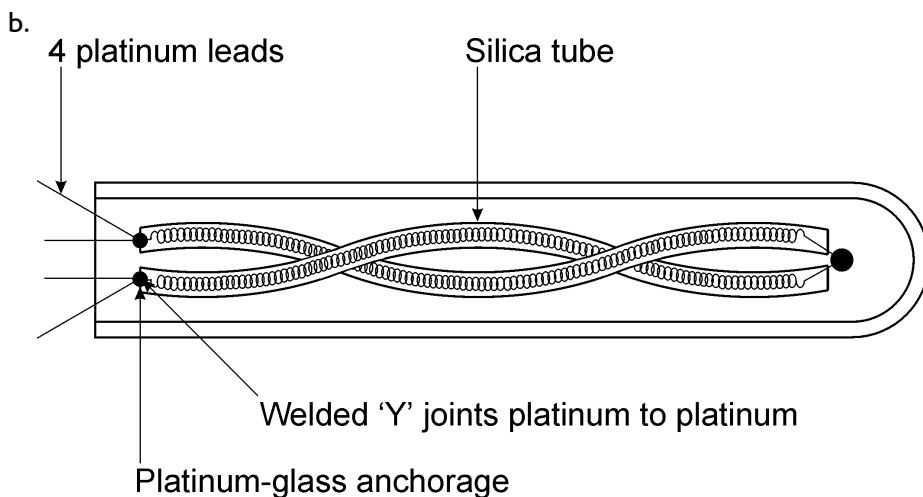
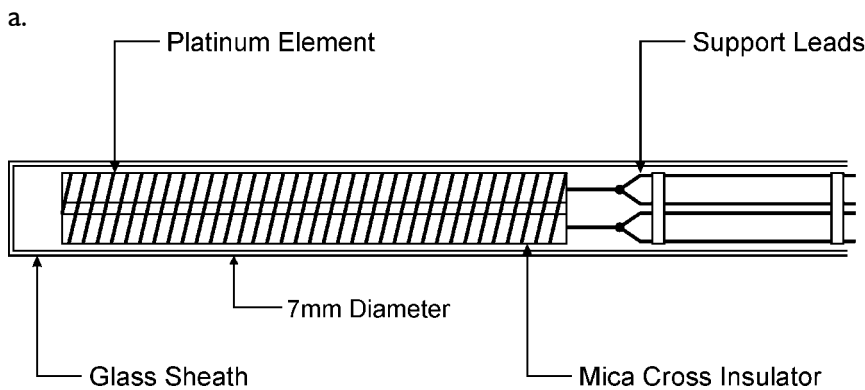

c.

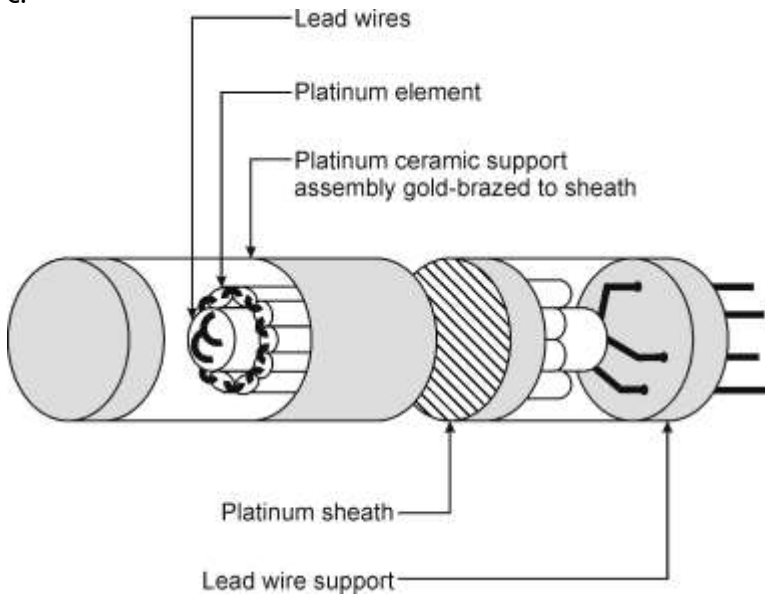
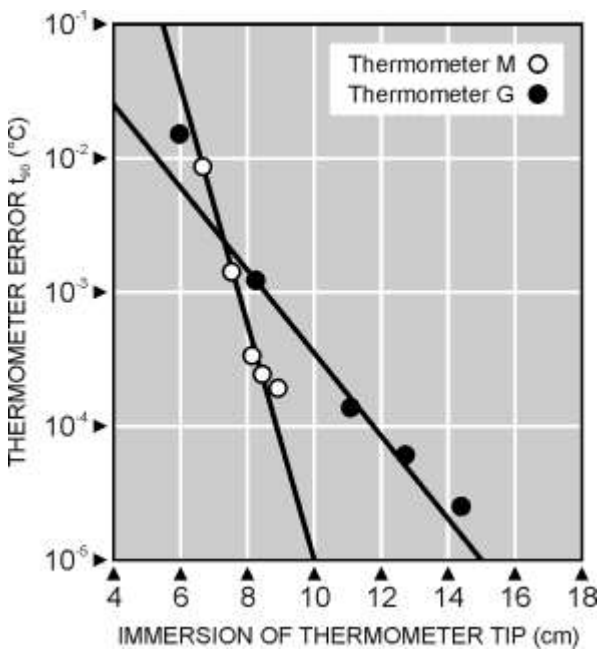

Figure 1; Designs of resistance element found in long-stem platinum resistance thermometers

- a) bifilar winding on a mica former (Meyers Design)
- b) coil inside silica tubes (Barber Design)
- c) wires in alumina tubes; this type of element is usually mounted in an Quartz tube (Rosemount design)

An immersion of 15cm in a triple-point-of-water cell (which is demanded for measurements of the highest accuracy) is not difficult to achieve, but at higher temperatures, it becomes difficult to produce regions of uniform temperature which are sufficiently long. The immersion required for a given accuracy does not depend strongly upon temperature because of the logarithmic nature of the dependence. For example, in Figure 2 the temperature difference between thermometer G and the triple point decreases by a factor of 10 for an increase in immersion of just over 3cm. Thus, if the outside temperature differs by 250°C rather than 25°C from that of the medium being measured, an additional 3cm immersion is all that is required. Conversely, if the outside temperature differs by only 2.5°C, only 3cm less immersion is required. Thus, if the temperature of a water or oil bath at 20°C is being measured in a room at 22.5°C, an immersion of 9cm would be required for an accuracy of 0.1 mK, compared with an immersion of 12cm in the triple-point-of-water cell. This also explains why it is so difficult to make accurate measurements of high temperatures. The uniformity of temperature demanded is much greater than might be expected. On the basis of a 3cm immersion being required for each factor of 10 in temperature difference, it is obvious that a temperature difference of 0.01°C at a distance of 6cm from the element will produce the same error as a difference of 1°C at a distance of 12cm.



THE LONG TERM PERFORMANCE OF A 670 THERMOMETER

INTRODUCTION

The Model 670 Thermometer is the first design specifically targeted for use up to the Aluminium Temperature.

The construction incorporates the best features of the Meyers 25.5 ohm thermometer with the main changes being that Quartz has been substituted for the Mica and that high temperature thermometry improvements have been incorporated to allow for the differential expansions between Platinum and Quartz over this wide temperature range.

In March 1996 such a thermometer with serial number 670/018 was purchased for use in our UKAS Laboratory.

Upon arrival it was calibrated from Aluminium to triple point of water. Subsequently it has performed as a monitor thermometer in the whole range of fixed points Tin, Zinc and Aluminium.

After 6 months of continuous use, it was recalibrated.

The initial and latest calibrations are presented here to show the long term performance of this new design.

RESULTS

Mean Values	April	June	October	Changes over 6 months (mK)
W Al	3.3755184	3.3755166	3.3755214	+0.8mK
W Zn	2.5686007	2.5686057	2.568605	+1.2mK
W Sn	1.8926249	1.8926281	1.8926243	-0.1mK
W Ga	1.1181172	---	1.1181173	+0.3mK
RTPW	25.620188	25.620128	25.619916	-0.00027Ω

CONCLUSION

This is now our most stable thermometer.

UKAS Accreditation Schedule Issue 037

Schedule of Accreditation
issued by
United Kingdom Accreditation Service
21 - 47 High Street, Feltham, Middlesex, TW13 4UN, UK

 0175 Accredited to ISO/IEC 17025:2005	Isothermal Technology Ltd	
	Issue No: 037	Issue date: 19 March 2007
Pine Grove Southport Merseyside PR9 9AG	Contact: Mr J P Tavener Tel: +44 (0)1704 543830/544611 Fax: +44 (0)1704 544799 E-Mail: callab@isotech.co.uk Website: www.isotech.co.uk	
Calibration performed at the above address only		

DETAIL OF ACCREDITATION

Measured Quantity Instrument or Gauge	Range	Best Measurement Capability Expressed as an Expanded Uncertainty (k=2)	Remarks
TEMPERATURE			
Platinum thermocouples Calibration by comparisons	-50 °C to 0 °C 0 °C to 50 °C 50 °C to 660 °C 660 °C to 1100 °C 1100 °C to 1300 °C	0.5 °C 0.45 °C 0.4 °C 0.7 °C 1.7 °C	Thermocouples without a cold junction will have increased uncertainty
Calibrations at fixed points	232 °C up to 962 °C	0.4 °C	
Gold/Platinum thermocouples Calibration at fixed points	0 °C to 1000 °C 420, 680, 962 °C	0.1 °C 0.06 °C	
Other thermocouples	-196 °C	0.3 °C	
	-60 °C to 0 °C	0.25 °C	
	0 °C to 50 °C	0.1 °C	
	50 °C to 300 °C	0.25 °C	
	300 °C to 420 °C	0.30 °C	
	420 °C to 660 °C	0.4 °C	
Compensating and extension cables	660 °C to 1100 °C	0.8 °C	
	1100 °C to 1300 °C	2.2 °C	
	-25 °C to 200 °C	1 °C	
Platinum resistance thermometers			
Calibration by comparisons	-30 °C to -40 °C	7.0 mK	
	-40 °C to +50 °C	4.0 mK	
	50 °C to 156 °C	5.0 mK	
	156 °C to 300 °C	6.5 mK	
	300 °C to 420 °C	20 mK	
	420 °C to 660 °C	35 mK	

<p>0175 Accredited to ISO/IEC 17025:2005</p>	<p>Schedule of Accreditation issued by United Kingdom Accreditation Service 21 - 47 High Street, Faltham, Middlesex, TW13 4UN, UK</p>
	<p>Isothermal Technology Ltd Issue No: 037 Issue date: 19 March 2007</p>

Calibration performed at main address only

Measured Quantity Instrument or Gauge	Range	Best Measurement Capability Expressed as an Expanded Uncertainty ($k=2$)	Remarks
4-wire platinum resistance thermometers			
Calibration at fixed points			Uncertainty in the determination of W_{10} used to calculate ITS-90 coefficients
See Note 1			
BP Nitrogen	-195.798 °C	5 mK	
TP Mercury	-38.8344 °C	0.24 mK	
MP Gallium	29.7646 °C	0.15 mK	
FP Indium	156.5985 °C	1.0 mK	Note: TP = Triple Point FP = Freezing Point MP = Melting Point BP = Boiling Point
FP Tin	231.928 °C	1.0 mK	
FP Zinc	419.527 °C	1.2 mK	
FP Aluminium	660.323 °C	2.0 mK	Note 1: Suitable only for HT/SPRTs with high stability. Includes extrapolation to zero power and immersion checks.
FP Silver	961.78 °C	7 mK	
See Note 2			
BP Nitrogen	-195.798 °C	10 mK	
TP Mercury	-38.8344 °C	2.0 mK	
MP Gallium	29.7646 °C	1.0 mK	
FP Indium	156.5985 °C	2.0 mK	Note 2: Suitable for most SPRTs using nominal current
FP Tin	231.928 °C	3.0 mK	
FP Zinc	419.527 °C	3.5 mK	
FP Aluminium	660.323 °C	10 mK	
FP Silver	961.78 °C	40 mK	
Fixed Point Cells			
See Note 3			
TP Mercury	-38.8344 °C	0.22 mK	Note 3: Suitable for optimal realisations. Includes 3 melts, 3 freezes, 2 intercomparisons
TP Water	0.01 °C	0.07 mK	
MP Gallium	29.7646 °C	0.07 mK	
FP Indium	156.5985 °C	0.65 mK	
FP Tin	231.928 °C	0.6 mK	
FP Zinc	419.527 °C	0.9 mK	
FP Aluminium	660.323 °C	1.1 mK	
FP Silver	961.78 °C	2.0 mK	
See Note 4			
TP Mercury	-38.8344 °C	1.0 mK	Note 4: Appropriate for slim cells. Includes 1 melt, 1 freeze, 1 intercomparison sequence using a monitor SPRT.
TP Water	0.01 °C	0.5 mK	
MP Gallium	29.7646 °C	1.0 mK	
FP Indium	156.5985 °C	2.0 mK	
FP Tin	231.928 °C	2.0 mK	
FP Zinc	419.527 °C	2.0 mK	
FP Aluminium	660.323 °C	6 mK	
FP Silver	961.78 °C	30 mK	
Metal Block Calibrators and Portable Liquid Baths	0 °C -80 °C to 0 °C 0 °C to 156 °C 156 °C to 300 °C 300 °C to 420 °C 420 °C to 660 °C 660 °C to 1100 °C 1100 °C to 1300 °C	10 mK 25 mK 20 mK 35 mK 50 mK 65 mK 1.0 °C 3.0 °C	Suitable for zero reference baths

 0175 Accredited to ISO/IEC 17025:2005	Schedule of Accreditation issued by United Kingdom Accreditation Service 21 - 47 High Street, Feltham, Middlesex, TW13 4UN, UK		
	Isothermal Technology Ltd Issue No: 037 Issue date: 19 March 2007		
Calibration performed at main address only			
Measured Quantity Instrument or Gauge	Range	Best Measurement Capability Expressed as an Expanded Uncertainty (k=2)	Remarks
ELECTRICAL			
DC VOLTAGE	Up to 140 mV 140 mV to 1.4 V 1.4 V to 14 V	12 ppm + 0.6 μ V 12 ppm + 1.3 μ V 12 ppm + 12 μ V	
DC RESISTANCE	0.1 Ω to 10 Ω 10 Ω to 250 Ω 250 Ω to 1000 Ω 1 k Ω to 10 k Ω 10 k Ω to 100 k Ω	0.3 ppm + 0.1 μ Ω 0.3 ppm + 2.5 μ Ω 0.4 ppm + 10 μ Ω 12 ppm 12 ppm	Resistors suitable for oil immersion can be measured over the range 10 °C to 30 °C
Spot Values	25 Ω 25 Ω	0.061 ppm 0.066 ppm	Generation of resistance Measurement of resistance
AC RESISTANCE			
2.5 Ω to 400 Ω 400 Ω to 1000 Ω	75 Hz 75 Hz	15 ppm 100 ppm	The uncertainties can only be realised for resistors with suitable AC characteristics
Spot Value			
25 Ω	75 Hz	5 ppm	
TEMPERATURE SIMULATION			
Temperature indicators and simulators, calibration by electrical simulation, for the following sensor types:			
Base metal thermocouple	-200°C to 1600°C	0.3°C	including cold junction compensation
Noble metal thermocouple	-200°C to 1760°C	0.4°C	including cold junction compensation
Resistance sensors (Pt100)	-200°C to 800°C	0.02°C	
END			

SPRT REPACKING INSTRUCTIONS USING THE **WOODEN TRANSPORT CRATE 912-00-00**



1 Once the SPRT is safe within the carrying case a foam end piece is placed over each end.

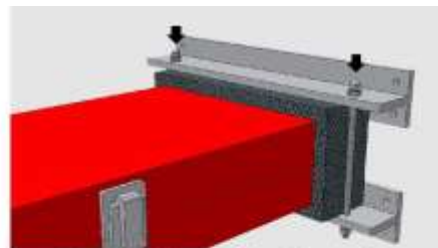

2 Place two of the 'T' shaped bars on either end of the foam as shown and tighten into place with the four shorter threaded rods, with dome nuts and above and two normal nuts beneath.

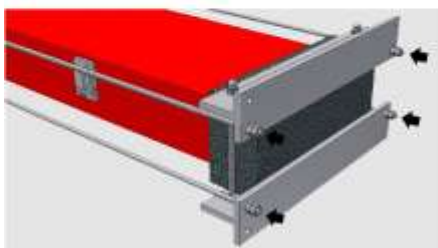

3 With all four 'T' bars in place the four longer threaded rods are now used to pull the foam blocks towards each other. Once tight they are held in place with two nuts at each end.

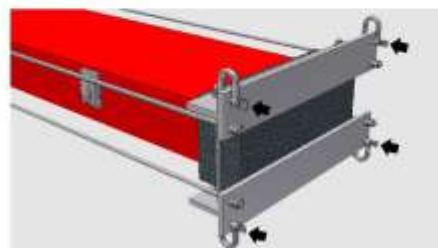

4 Now that the foam blocks and 'T' bars hold the SPRT case securely in place the shackles are threaded through each of the four outermost holes on the 'T' bars as shown.

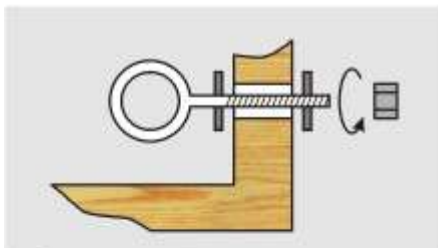

5 Putting the SPRT case aside the eight eye-bolts are pushed through the four holes in the side panels of the shipping crate and fastened as shown above.

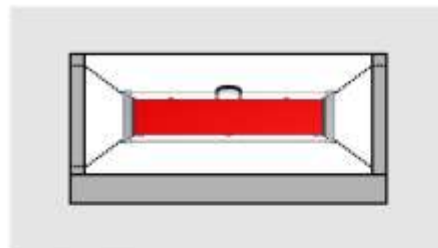

6 The SPRT case can now be suspended in the crate using the eight shock-cords. The SPRT case can be rested at the correct height before the upper four shock-cords are pulled tight.

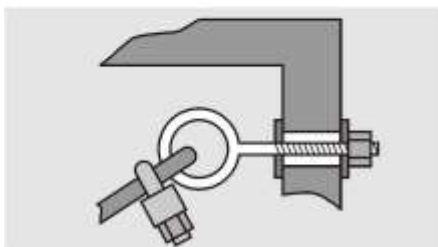

7 Once the shock-cords have been pulled tight the 'U' shackles are used to hold the shock-cord tight as shown above. This is repeated at all eight corners of the crate.

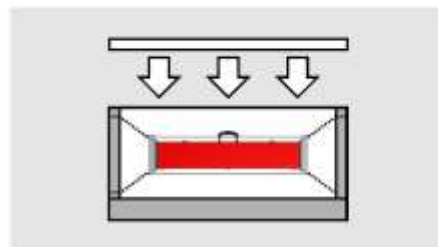

8 Once the SPRT case is held firmly in the centre of the crate replace the top panel of the shipping crate and fasten in place with screws. The SPRT is now ready to send.

Ensure to label the crate thoroughly with **"FRAGILE"** and **"THIS WAY UP"** labels and arrange adequate insurance cover.

SPRT REPACKING INSTRUCTIONS USING THE WOODEN TRANSPORT CRATE 93 I-22-128

- 1 Check that the inner carton is still attached and permanently suspended by its pre-fixed elastic cords.



- 2 Place the two poly end foam blocks over the ends of the closed storage case.



- 3 Lower into the inner cardboard carton.



- 4 Carefully close the inner carton lid and seal using the velcro straps (when supplied) or strong packing tape.



- 5 Replace the top panel and fasten in place with screws.



- 6 The SPRT is ready to send.

Ensure to label the crate thoroughly with “**FRAGILE**” and “**THIS WAY UP**” labels and arrange adequate insurance cover.

SPRT REPACKING INSTRUCTIONS USING THE CARDBOARD CARTON

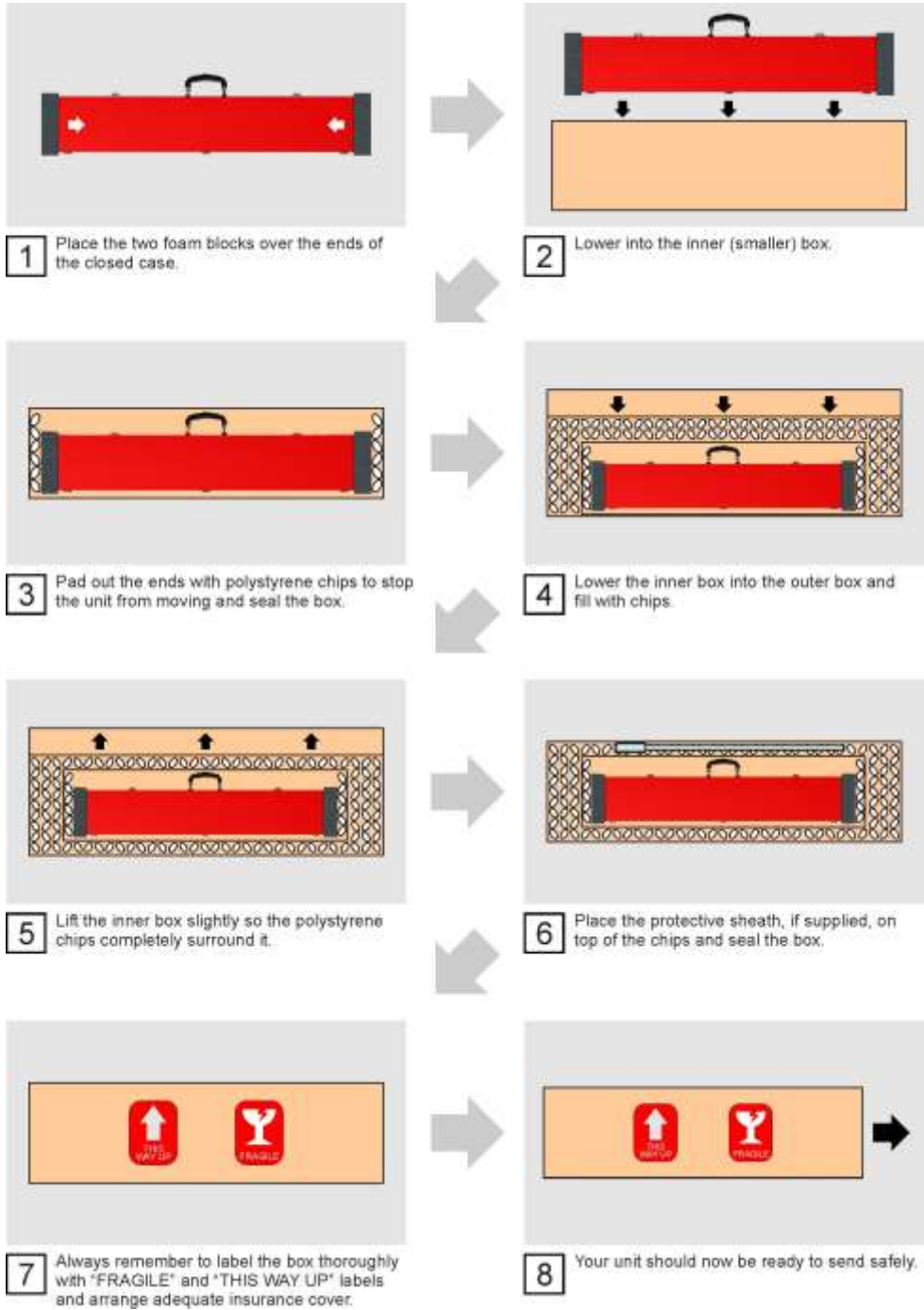

Ensure to label the carton thoroughly with “**FRAGILE**” and “**THIS WAY UP**” labels and arrange adequate insurance cover.